

# JA9211

## AÉREO 70

# Instruções de montagem

## Assembly Instructions / Instrucciones de Montaje







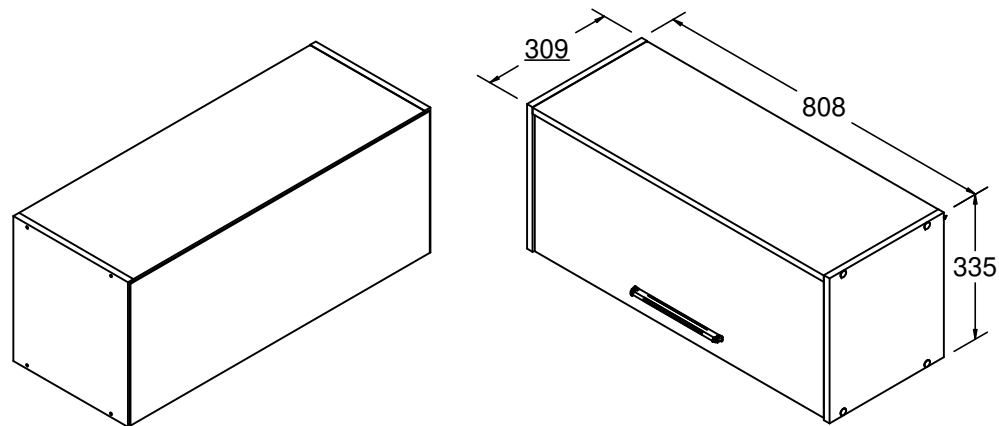







**DELMARCO**

1

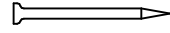

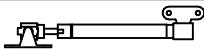
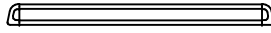
COD	DESCRIÇÃO/DESCRIPCIÓN/DESCRIPTION	DIMENSÃO	QTD
01	LATERAL DIREITA/LATERAL DERECHA/RIGHT SIDE	335 x 306 x 15	1
02	LATERAL ESQUERDA/LATERAL IZQUIERDA/LEFT SIDE	335 x 306 x 15	1
04	PRATELEIRA/ESTANTE/SHELF	778 x 288 x 15	1
08	CHAPÉU/TAPA/TOP	778 x 306 x 15	1
11	PORTA/PUERTA/DOOR	772 x 315 x 15	1
60	COSTA/FONDO/BACK	800 x 328 x 3	1

LISTA DE ACESSÓRIOS		
COD	DESCRIÇÃO	QTD
A	 CAVILHA Ø6X30 CLAVIJA Ø6X30 WOOD DOWEL Ø6X30	8
B	 PARAFUSO CC 3,5X14 REBAIXE TORNILLO CC 3,5X14 SCREW CC 3,5X14	14
C	 PARAFUSO CC 3,5X40 TORNILLO CC 3,5X40 SCREW CC 3,5X40	8
DA	 DOBRADIÇA BISAGRA HINGE	2
E	 PARAFUSO CF 3,5X30 TORNILLO CF 3,5X30 SCREW CF 3,5X30	2
F	 PARAFUSO CF 4,5X50 TORNILLO CF 4,5X50 SCREW CF 4,5X50	2
G	 SUPORTE FIXAÇÃO SOPORTE DE FIJACIÓN FIXING SUPPORT	2
H	 PROTEÇÃO SUP CANTONEIRA PROTECCIÓN ANGLE BRACKET	2
I	 BUCHA PLÁSTICA CASQUILLO BUSHING	2
M	 PREGO 10X10 CLAVO 10X10 NAIL	20
N	 ADESIVO TAPA FURO ADHESIVO STICKER	8
PI	 PISTÃO PISTON PISTON	1
PX	 PUXADOR TIRADOR HANDLE	1
V	 COLA PEGAMENTO GLUE	1
Y	 PARAFUSO CC 3,5X30 TORNILLO CC 3,5X30 SCREW CC 3,5X30	2

REV.: 00  
DATA: 21/08/2023

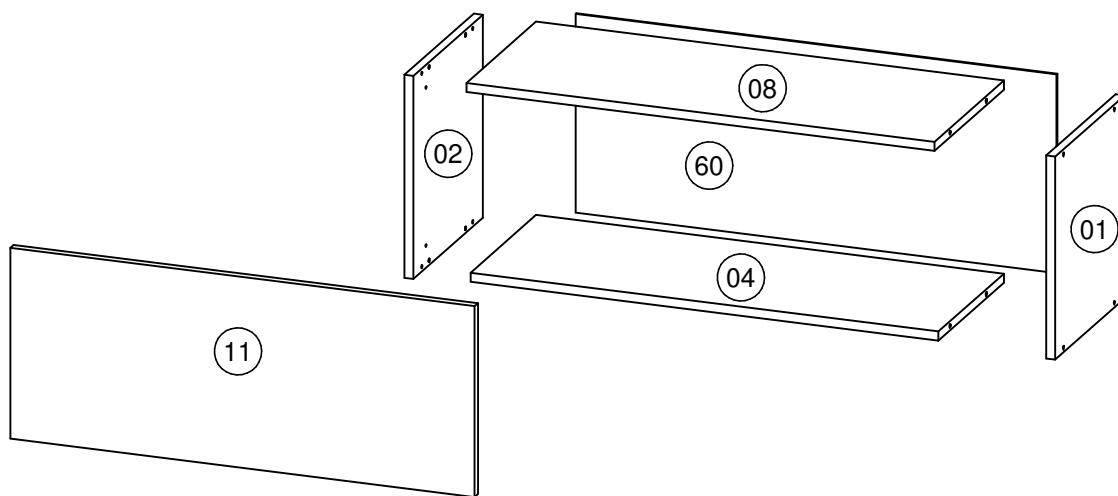

FERRAMENTAS NECESSÁRIAS:  
HERRAMIENTAS NECESARIAS:  
NECESSARY TOOLS:

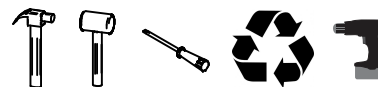

**"IMPORTANTE LER COM ATENÇÃO  
E GUARDAR PARA EVENTUAIS  
CONSULTAS".**

**"IMPORTANTE LEER CON ATENCIÓN Y GUARDAR PARA  
EVENTUALES CONSULTAS".**

**"IMPORTANT TO READ CAREFULLY AND SAVE FOR ANY  
QUERIES".**

