



Rodovia SC-492 - Km 10 - B. Industrial
89905-000 - Bandeirante - SC
Fone: (49) 3622-4549
e-mail: mxmoveis@mxmoveis.com.br



Ref. TVE03

**Torre Quente 700
Cozinha/Cocina
Verace**

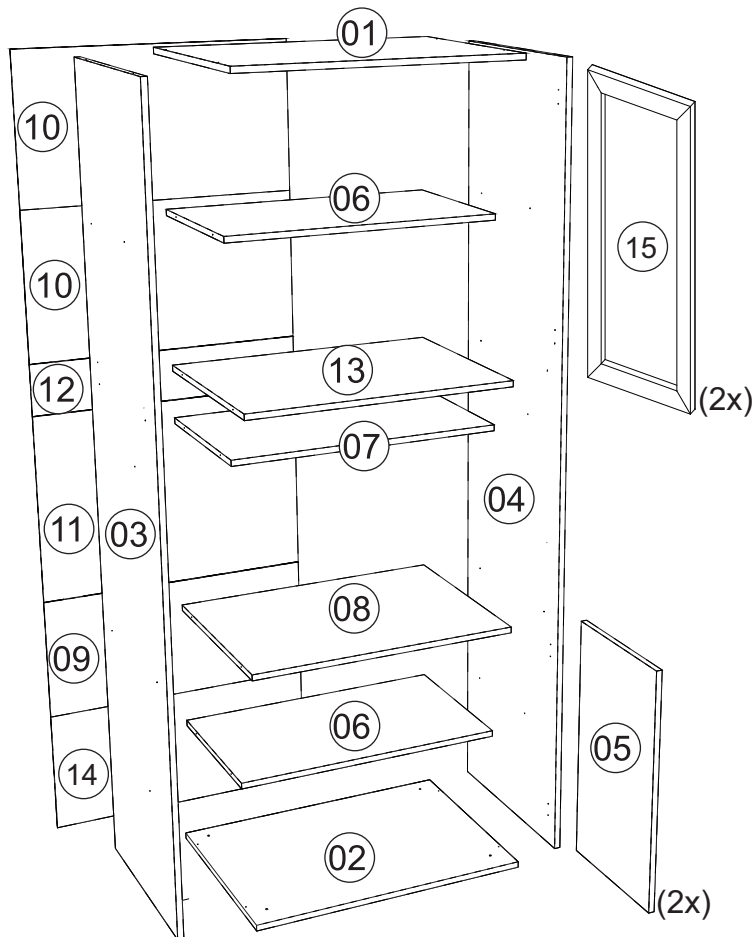

Nº	CÓDIGO ASSISTÊNCIA	NOME DA PEÇA/DESCRIPCIÓN PIEZAS	MEDIDAS (mm)	QTD.	CÓDIGO DAS PEÇAS/CÓDIGO PIEZAS
					MARROCOS OFF WHITE
01	TVE03.05.00	Base superior/Base superior	700x516x15	01	200376
02	TVE03.01.00	Base inferior/Base inferior	700x516x15	01	200375
03	TVE03.18.00	Lateral externa esquerda/Lateral izquierda	1990x496x15	01	200374
04	TVE03.17.00	Lateral externa direita/Lateral derecha	1990x496x15	01	200373
05	TVE03.25.00	Porta/Puerta	616x339x15	02	200381
06	TVE03.02.00	Base interna/Base	670x400x15	02	200379
07	TVE03.02.01	Base interna/Base	670x400x15	01	200380
08	TVE03.33.00	Tampo/Tapa	670x496x15	01	200378
09	TVE03.13.06	Forro torre/Revés	690x293x2,5	01	201746
10	TVE03.13.00	Forro torre/Revés	690x379x2,5	02	200369
11	TVE03.13.02	Forro torre/Revés	690x456x2,5	01	200371
12	TVE03.13.03	Forro torre/Revés	690x161x2,5	01	200372
13	TVE03.01.01	Base inferior/Base inferior	670x496x15	01	200377
14	TVE03.13.07	Forro torre/Revés	690x335x20	01	201747
15	1860	Porta vidro/Puerta vidrio	746x339x20	02	

Ferragens/Herrajes

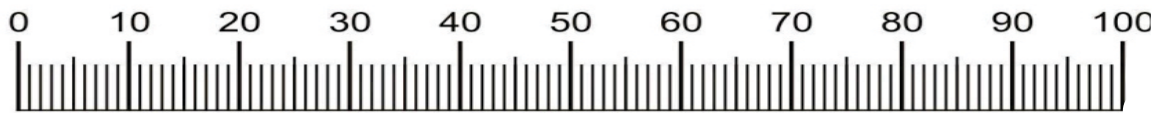
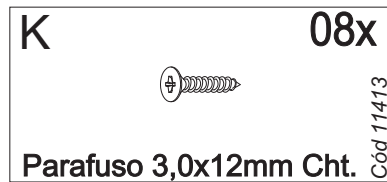
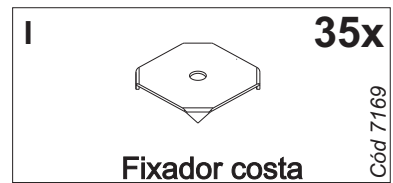
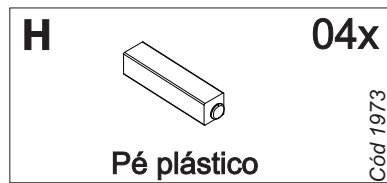
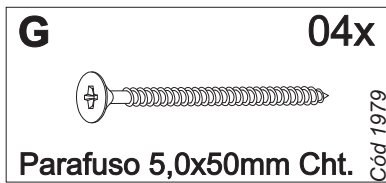
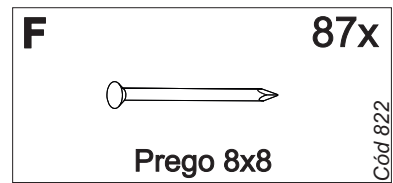
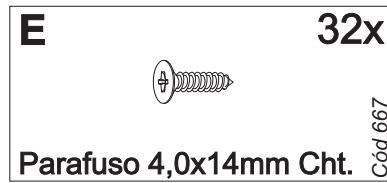
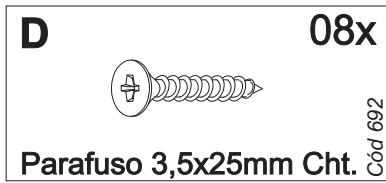
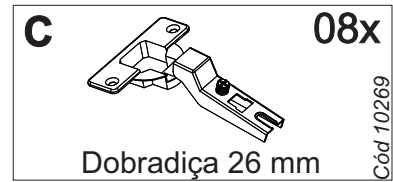
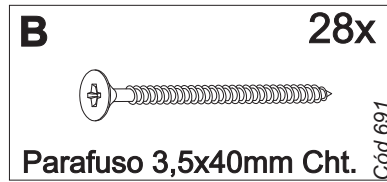
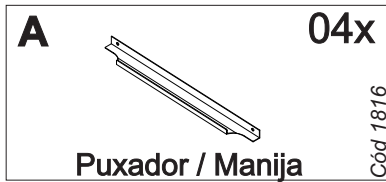

Medidas em mm

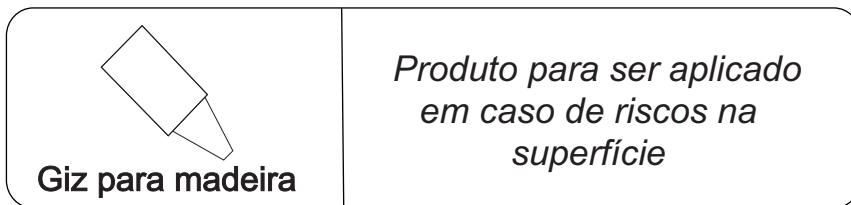
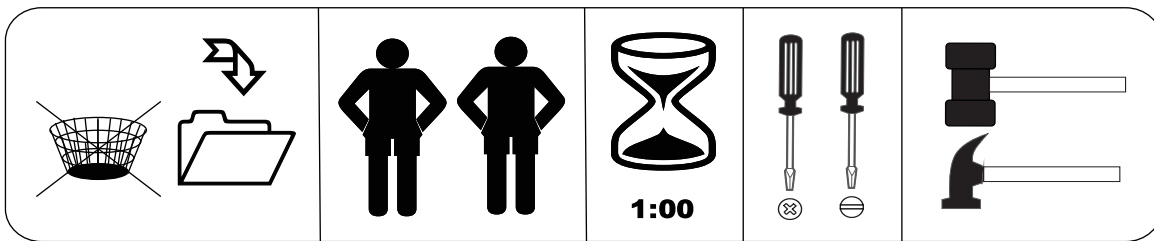

Pré-Montagem/Preparación Piezas

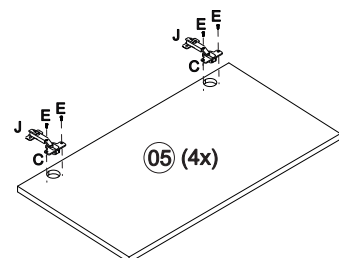
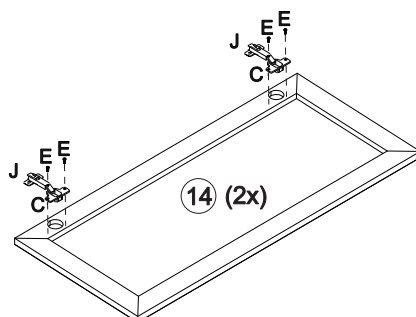
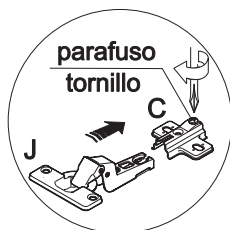

Montagem/Montaje

01

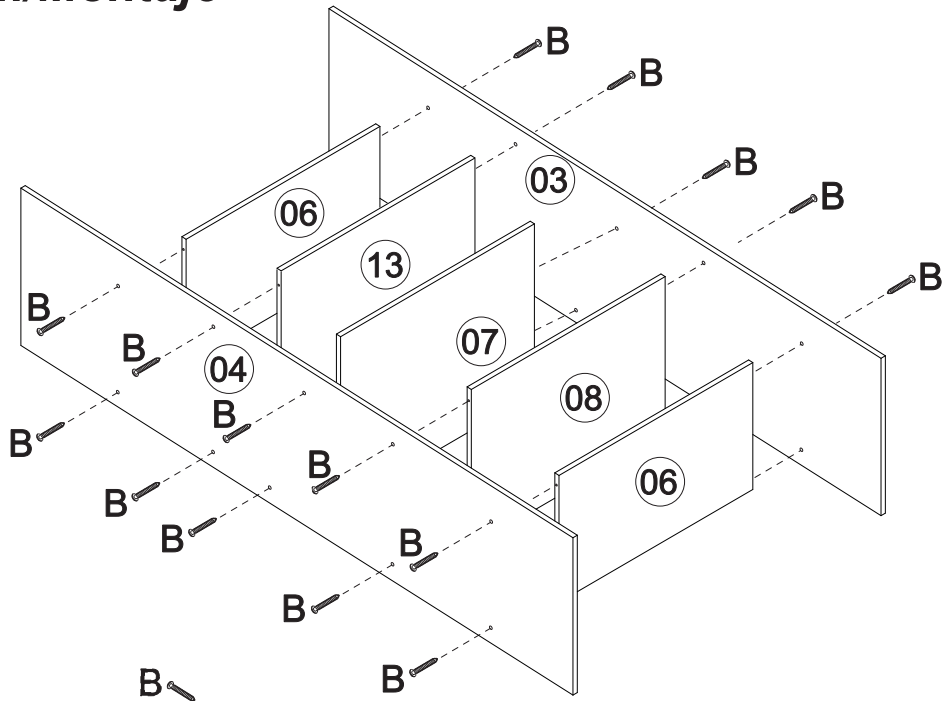

02

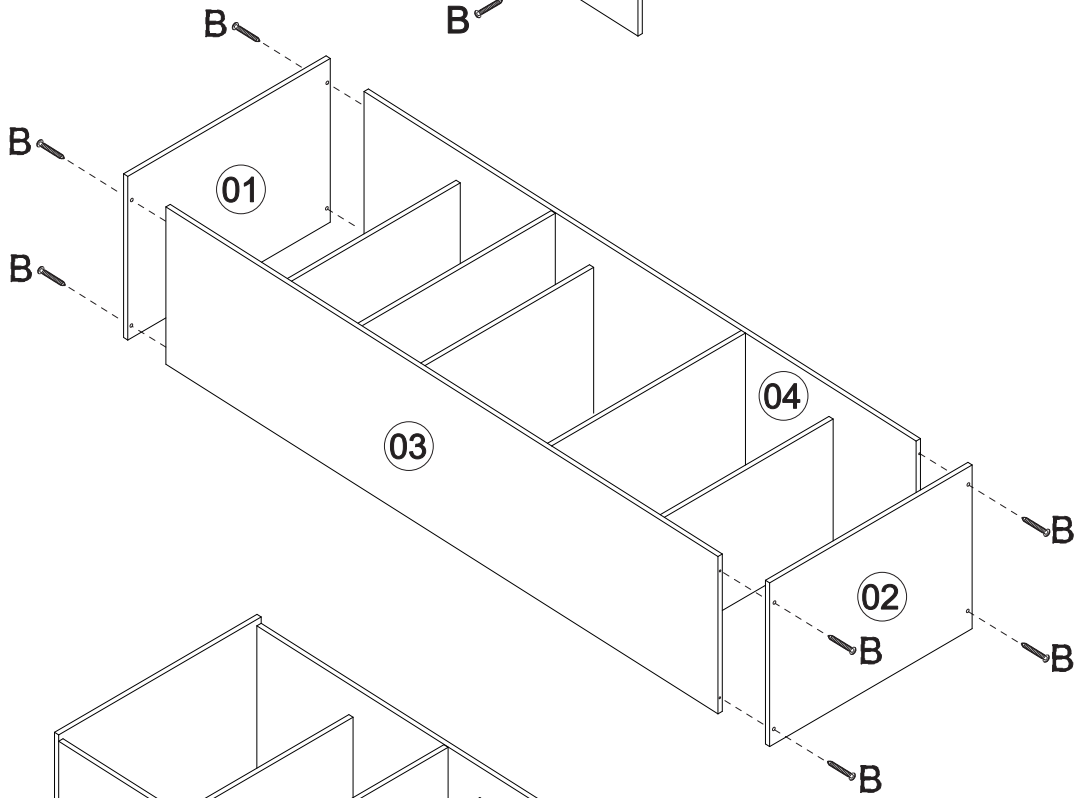

03

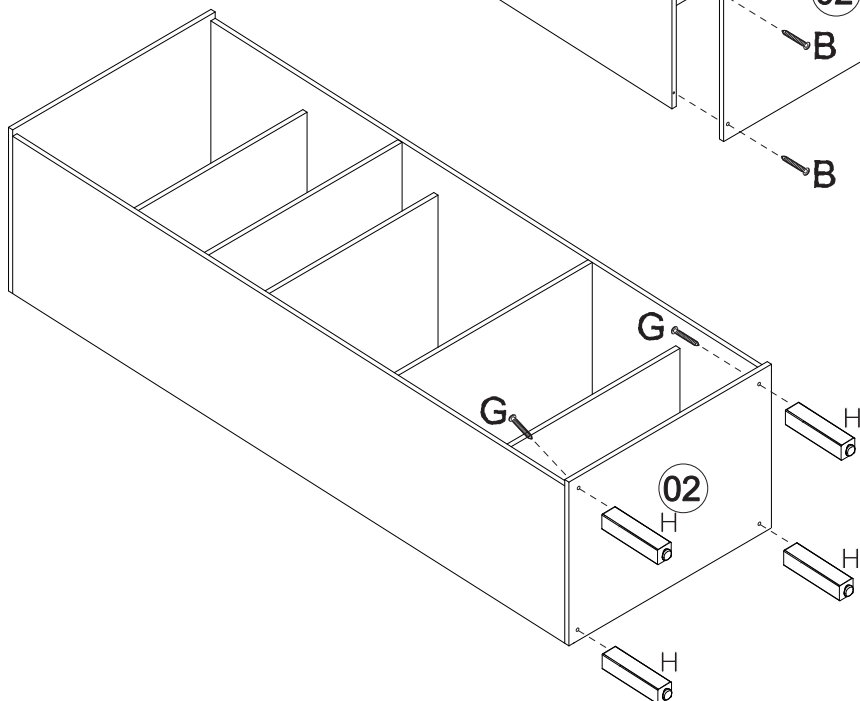

Montagem/Montaje

04

ATENÇÃO!!!

É importante colocar o móvel no esquadro antes de fixar as costas. Para isto utilize uma trena observando que a medida 1 deve ser igual à medida 2.

ATENCIÓN!!!

Es importante hacer una escuadra perfecta entre el fondo y la estructura del mueble. Observe que la medida 1 debe ser la misma que la medida 2.

**Quando usar forno
não fixar este forro (1
Cuando usar el horno
no utilice este revés (1**

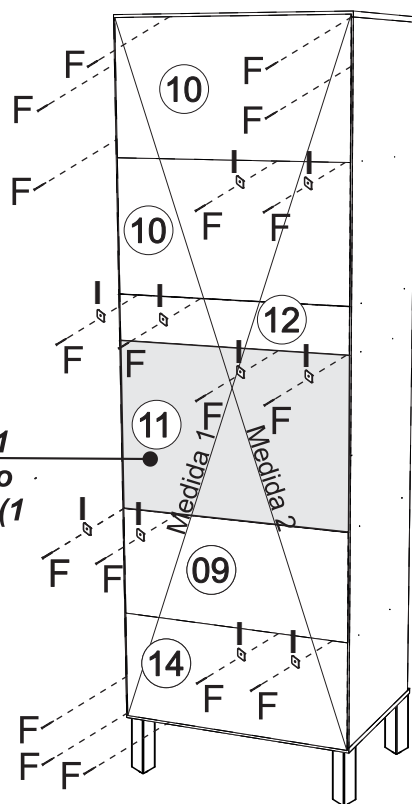

05

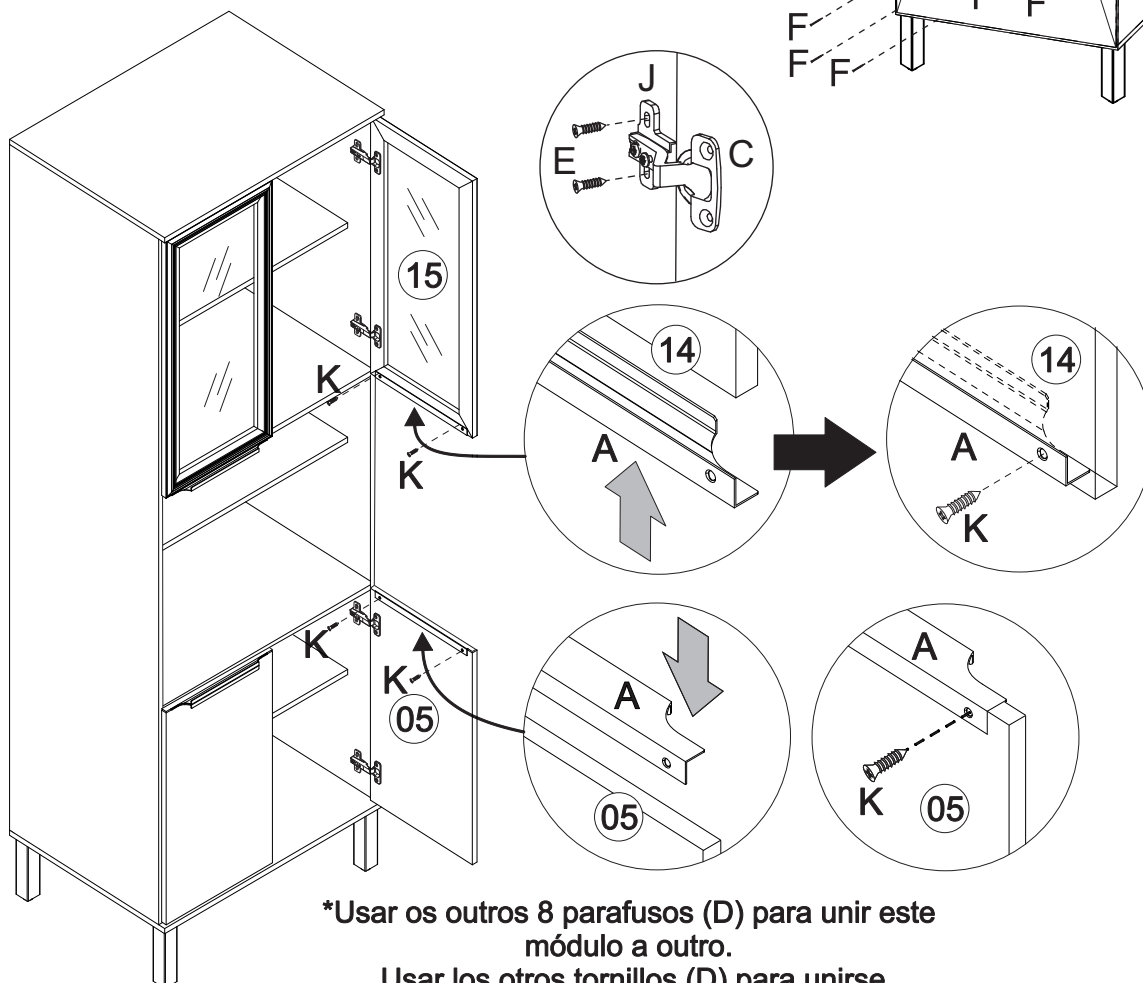

***Usar os outros 8 parafusos (D) para unir este módulo a outro.
Usar los otros tornillos (D) para unirse ste modulo a otro.**

Limpeza/Limpieza

- ≠ Use um pano levemente umedecido com água, seguido de pano seco.
- ≠ Use solamente un paño húmedo con agua y después un paño seco.
- ≠ Nunca utilize produtos químicos ou abrasivos.
- ≠ No utilice productos quimicos o abrasivos.