

mx

mxmóveis

Rodovia SC-492 - Km 10 - B. Industrial
89905-000 - Bandeirante - SC

Fone: (49) 3622-4549

e-mail: mxmoveis@mxmoveis.com.br

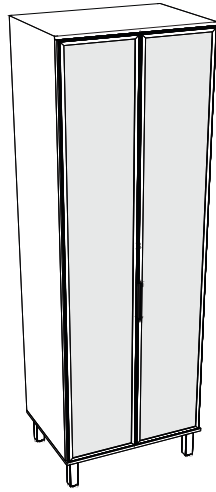

Ref. PTO02

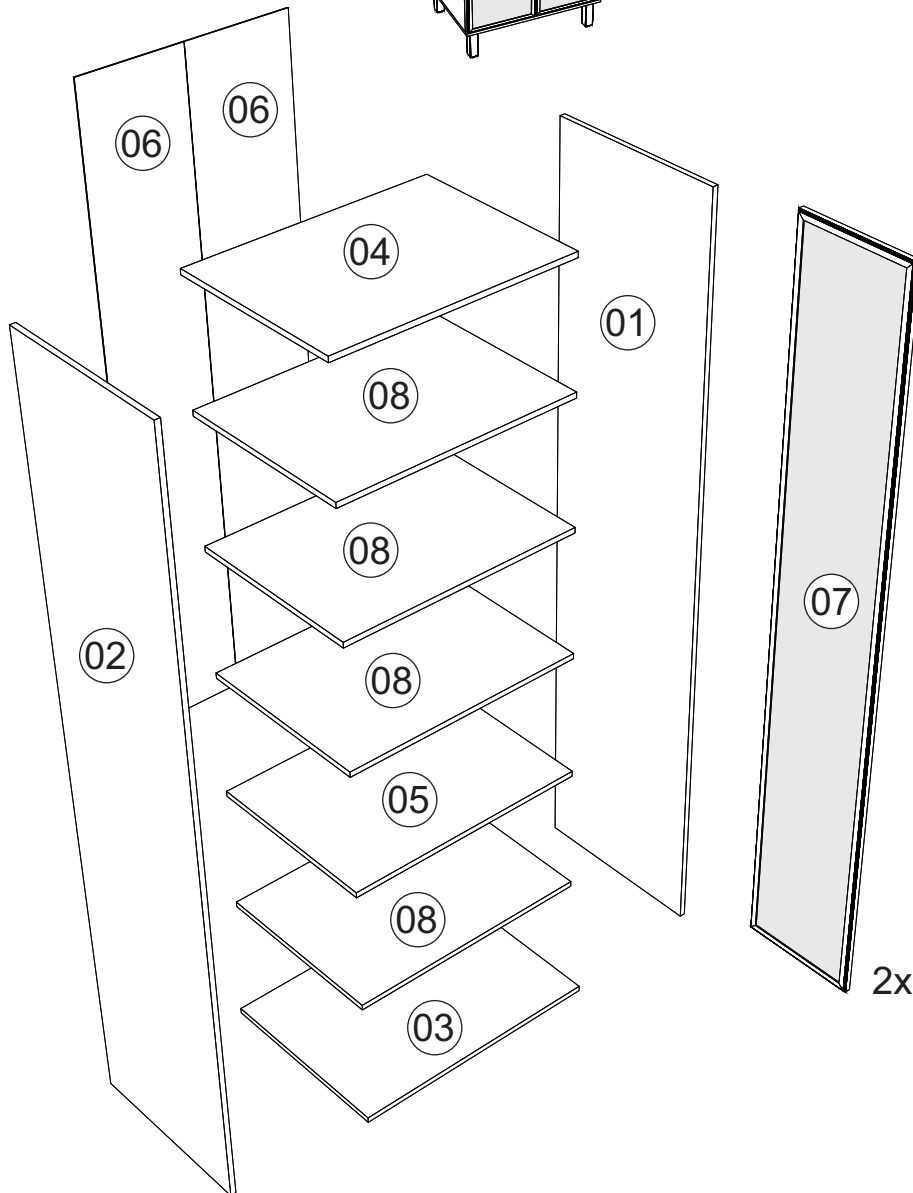

Cristaleira 700 Cozinha/Cocina TOSCANA

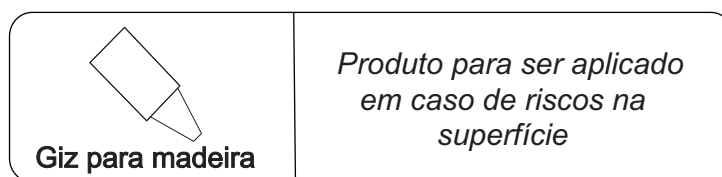
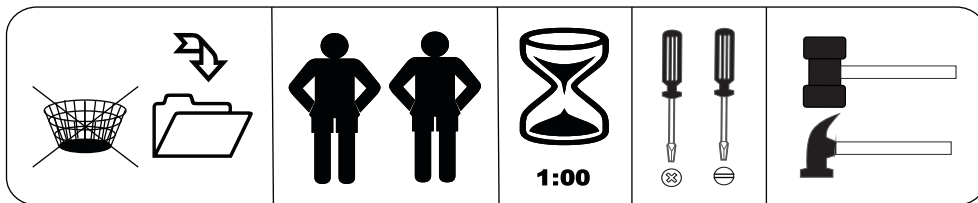
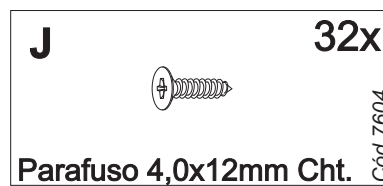
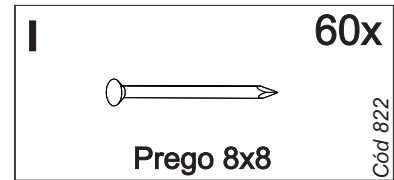
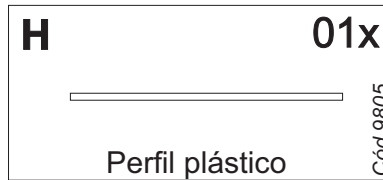
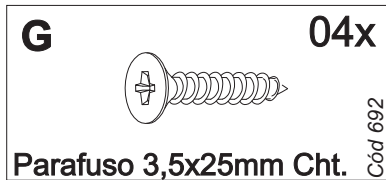
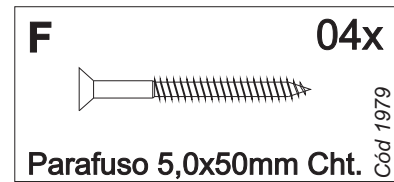
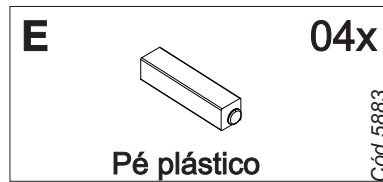
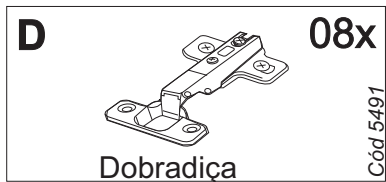
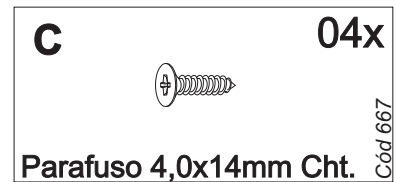
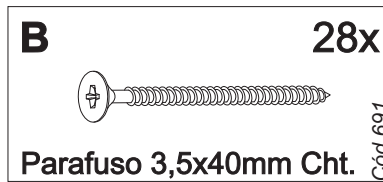
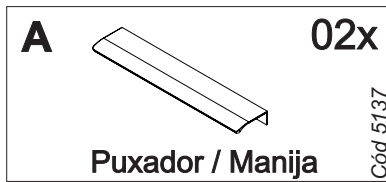

Nº	CÓDIGO ASSISTÊNCIA	NOME DA PEÇA/DESCRIPCIÓN PIEZAS	MEDIDAS (mm)	QTD.	CÓDIGO DAS PEÇAS/ CODIGO PIEZAS
					FREIJO/FREIJO
01	PTO02.17.00	Lateral externa direita/Lateral derecha	2100x496x15	01	209253
02	PTO02.18.00	Lateral externa esquerda/Lateral izquierda	2100x496x15	01	209255
03	PTO02.01.01	Base inferior/Base inferior	700x516x15	01	209260
04	PTO02.05.01	Base superior/Base superior	700x516x15	01	209259
05	PTO02.02.00	Base Interna/Base pequena	670x496x15	01	209256
06	PTO02.13.00	Forro/Revés	2116x345x2.5	02	209258
07	5269	Porta/Puerta	2089x339x20	02	
08	PTO02.02.01	Base Interna/Base pequena	670x450x15	04	209257

Ferragens/Herrajes



 *Usar os parafusos (G) para unir este módulo a outro.  Usar los tornillos (G) para unirse este módulo a otro.

Pré-Montagem/Preparación Piezas

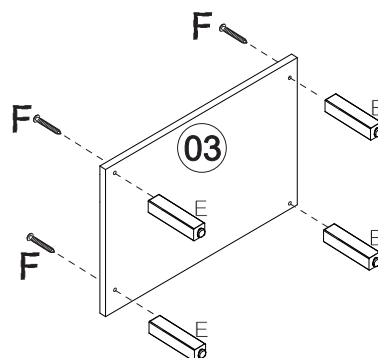

01

Montagem/Montaje

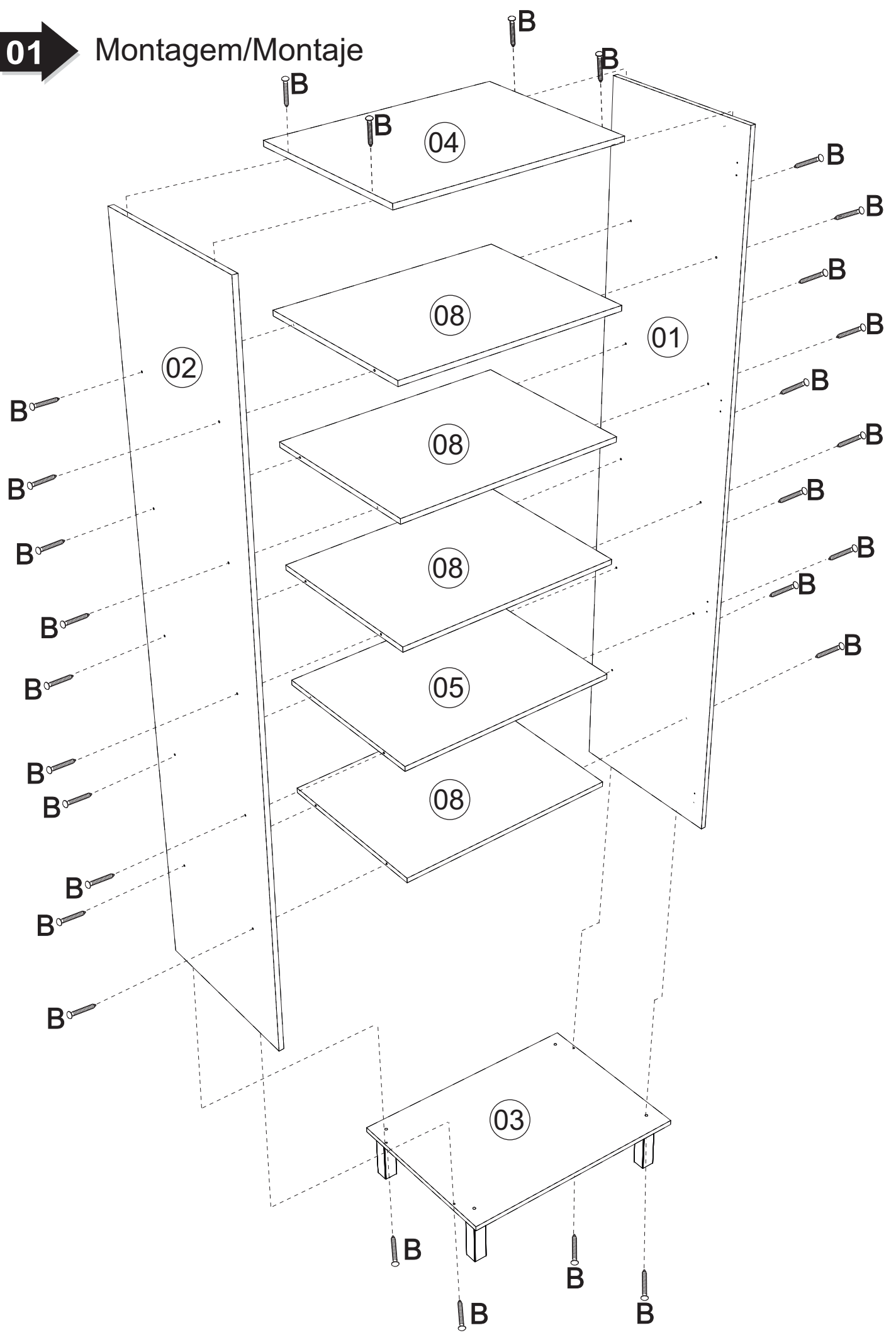

02 Montagem/Montaje

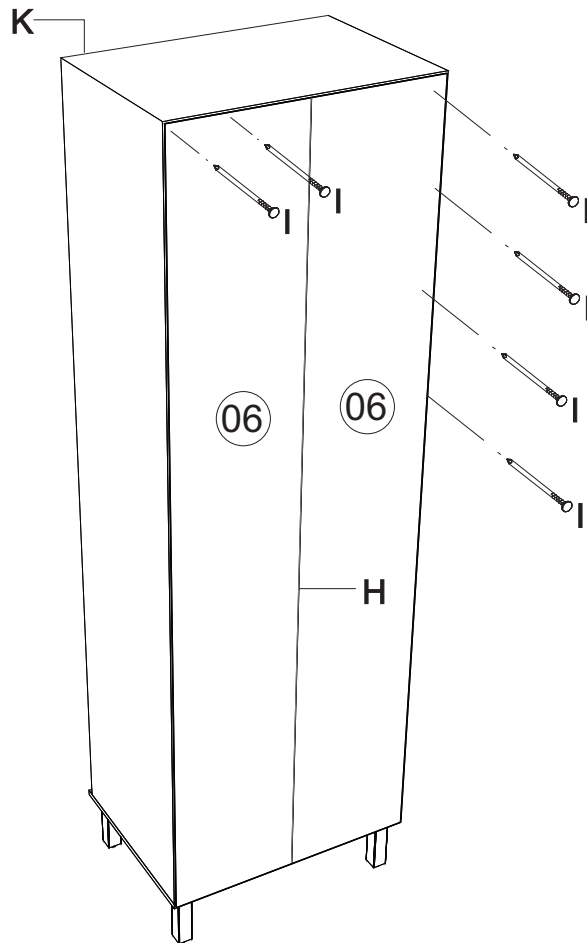

*Colocar um prego (I) a cada 100mm

03 Montagem/Montaje

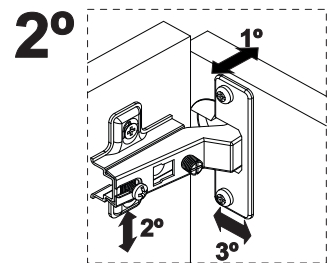
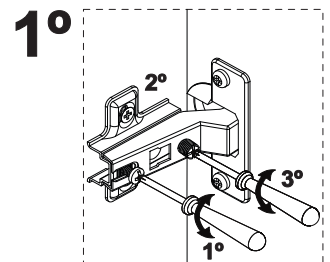
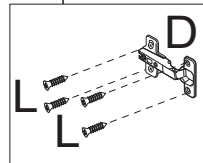
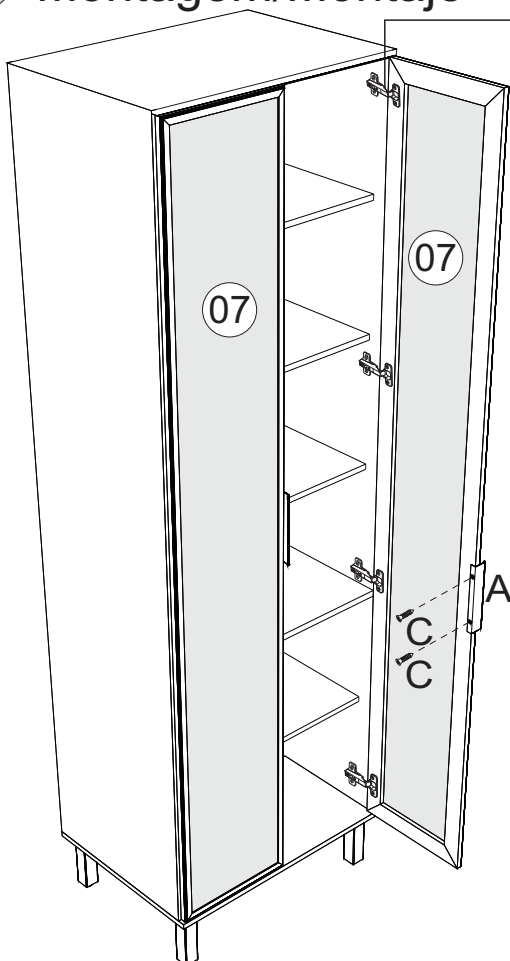

Limpeza/Limpieza

- ✗ Use um pano levemente umedecido com água, seguido de pano seco.
- ✗ Use solamente un paño húmedo con agua y después un paño seco.
- ✗ Nunca utilize produtos químicos ou abrasivos.
- ✗ No utilice productos químicos o abrasivos.