



**Cozinha Classy
Kitchen Classy
Cocina Classy**

Peça Pieza	Cod. Branco	Cod. Carv. Mel	Descrição	Description	Descripción	Qtde Qty Cant	Compr Lenght Largo	Larg. Widht Ancho	Esp. Tick. Esp.
1	P18870	P18809	Lateral Dir	Right side	Lateral Der	1	2200	490	15
2	P18865	P18802	Lateral Esq	Left side	Lateral Izq	1	2200	490	15
3	P18866	P18803	Tampo Inferior	Surface Bottom	superficie inferior	1	713	490	15
4	P18867	P18805	Tampo Forno	Oven Top	Top del horno	3	683	490	15
5	P18868	P18805	Tampo Superior	Top Size	Top Superior	1	713	510	15
6	P18869	P18806	Travessa Forno	Oven platter	Fuente de horno	2	683	76	15
7	P18811	P18811	Lateral Gaveta	Side Drawer	Lado del cajón	4	385	210	15
8	P18813	P18813	Traseiro Gaveta	Rear Drawer	Trasero cajón	2	656	210	15
9	P18812	P18812	Fundo Gaveta	Bottom Drawer	Fondo del cajón	2	654	406	2,5
10	P18807	P18807	Fundo Superior	Bottom background	Fondo Superior	2	545	348	2,5
11	P18808	P18808	Fundo Inferior	Bottom background	Fondo Abajo	2	737	348	2,5
12	38559	38528	Frente Gaveta	Front Drawer	Frontal cajón	2	696	337	18
13	38558	38527	Porta	Door	Puerta	2	530	346	10



Atenção com a cor do acabamento!
Em caso de assistência solicitar o código de acordo com a cor da peça/
Pay attention to the finish color!
In case of assistance, request the code according to the color of the part/
Presta atención al color del acabado!
En caso de asistencia solicitar el código según el color de la pieza.

Notas especiais/special notes/notas especiales:

- 1- Antes de montar o móvel, leia o Manual com atenção.
 Before mounting the mobile, read the manual carefully.
 Antes de montar el móvil, lea el manual cuidadosamente.
- 2 - Recomenda-se que a Montagem seja realizada conforme Manual de Montagem.
 It is recommended that the Assembly is held conforme Assembly Manual.
 Se recomienda que la Asamblea se celebra conforme Manual Asamblea.
- 3 - Certifique-se que a base onde o produto será Montado é Limpa e Plana.
 Asegúrese de que la base donde se montará el producto es limpio y Plana.
 Asegúrese de que la base donde se montará el producto es limpio y Plana.



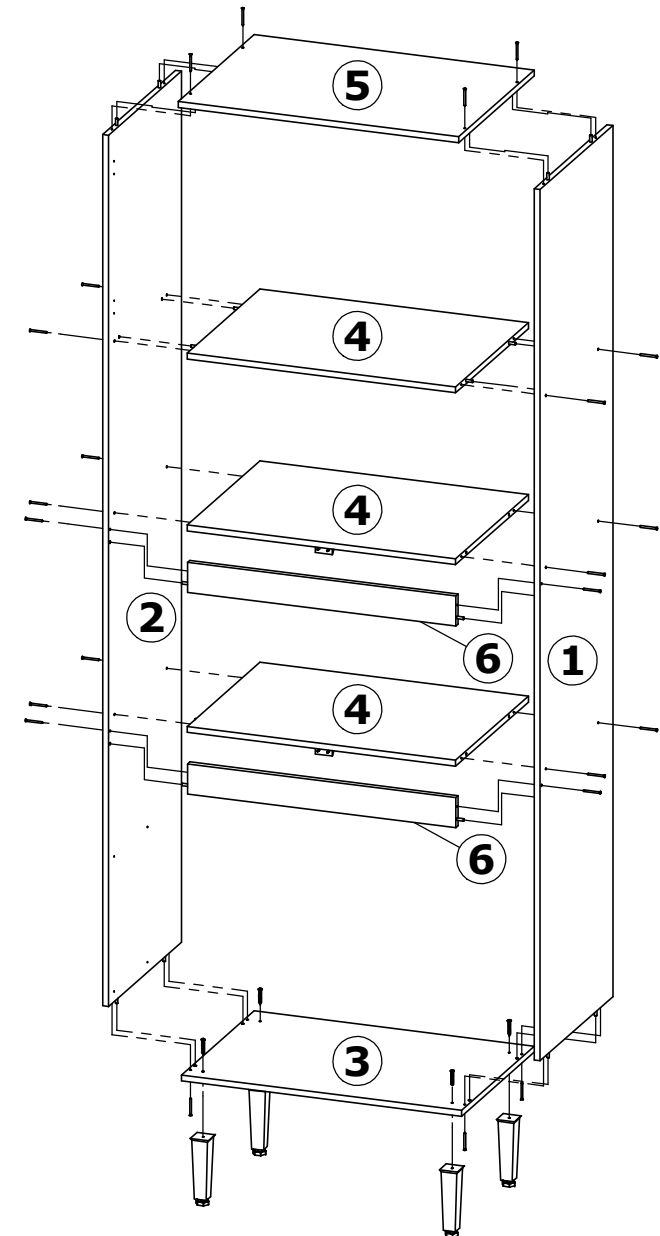









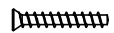
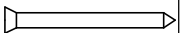
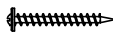

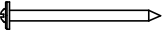









OBRIGADO./THANK YOU./GRACIAS.





Torre Quente 2P 2Gav Cozinha Classy/ Hot Tower 2P 2Gav Classy Kitchen/ Torre Caliente Cocina Classy

1º Passo / Step / Paso

Cod. Qnt.					
A 56	B 32	C 8	D 24	E 4	F 3
					
Parafuso 3,5x14 CP 25736	Parafuso 4x14CC 25673	Parafuso 3,5x25 CC 36977 - Zinc. Branco	Parafuso 4,0x45 CC 33002 - Zinc. Branco 33696 - Zinc. Amarelo	Parafuso 4,5x40 CF 29411	Paraf. União C/ Flange 33158
G 16	H 2	I 55	J 16	K 16	L 4
					
Parafuso Minifix 33160	Parafuso 5,0x50 CF 33172	Prego 10x10 CC 20179	Tampa Tambor 36012 - Cinza Social	Tambor 15x12 22388	Suporte Triangular 30094
M 2	N 24	O 1	P 8	Q 16	R 2
					
Cantoneira 20x20x42 36011 - Cinza Social	Cavilha 6x30 24603	Sachê Cola 36724	Batente Silicone 28309	Tapa Furo Adesivo 36479 - Branco 37069 - Carv. Mel	Proteção de Acab. 38480 - Branco 38526 - Carv. Mel
S 2	T 2	U 4	V 4	W 4	X 2
					
Sup. Aéreo Metálico 25768	Bucha 8MM 33408	Dobradiça c/ Amort. 38478	Calço Dob. c/ Amort. 38478	Pé Cônico 35571 - Champanhe	Trilho telescópico 36952
Y 1	Z 1	AA 4	AB 1	- -	- -
					
Perfil I 717mm 38522 - Linho	Perfil I 525mm 38523 - Linho	Puxador Lauren 37478 - Bronze	Adesivo Logotipo 31363		

Montagem da Gaveta/Drawer Assembly/Asamblea del cajón.

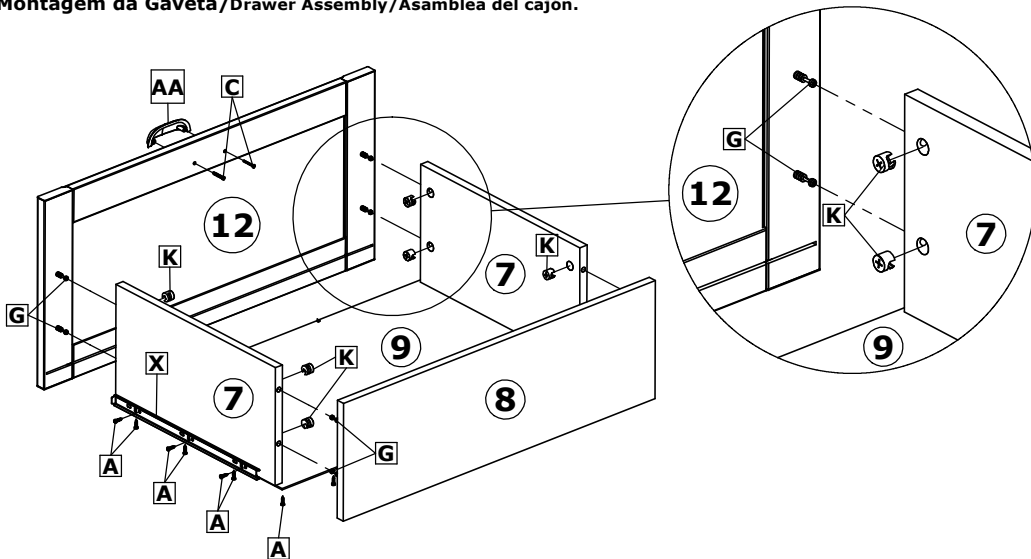

Fixar laterais ①, ②, Tapos ③, ④, ⑤ e travessas ⑥ com parafusos ④, ⑤, cavilha ⑥ e cantoneira ⑦ /
 Fix sides ①, ②, Tops ③, ④, ⑤ and beams ⑥ with screws ④, ⑤, bolt ⑥ and angle bracket ⑦ /
 Fije los lados ①, ②, las tapas ③, ④, ⑤ y las vigas ⑥ con tornillos ④, ⑤, perno ⑥ y soporte angular ⑦.

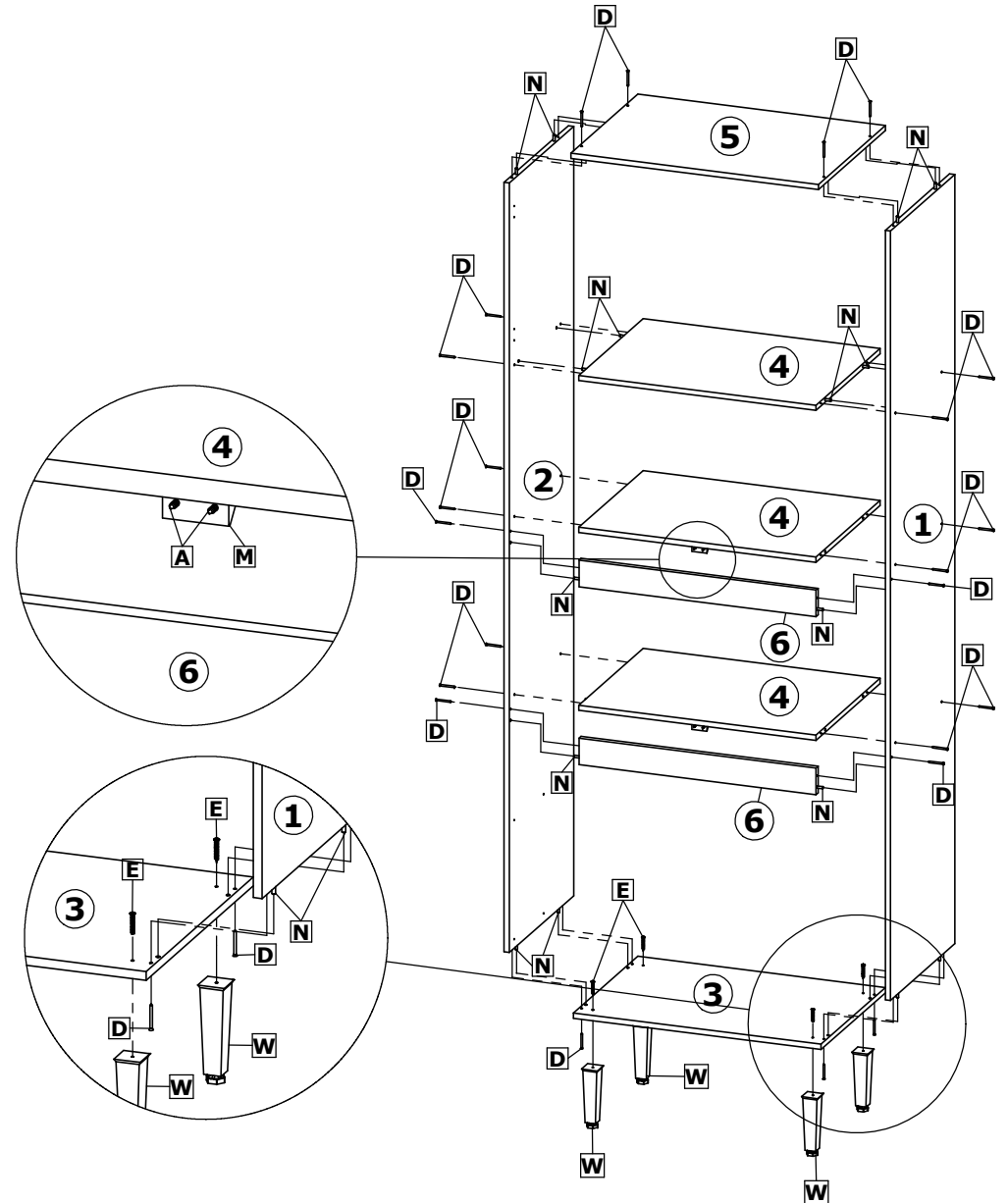



Torre Quente 2P 2Gav Cozinha Classy/ Hot Tower 2P 2Gav Classy Kitchen/ Torre Caliente Cocina Classy

2º Passo / Step / Paso

Fixar os fundos (10) e (11) com pregos (I),
Perfis (Y) e (Z) /
Fix the bottoms (10) and (11) with nails (I),
Profiles (Y) and (Z) /
Fije los fondos (10) y (11) con clavos (I),
Perfiles (Y) y (Z).

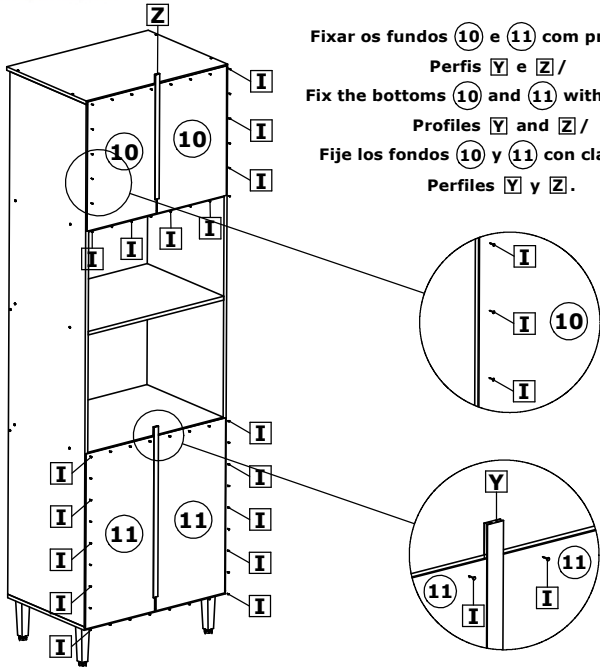

3º Passo / Step / Paso

Fixar trilho (X) com parafusos (B) /
Fix rail (X) with screws (B) /
Fix rail (X) with screws (B).

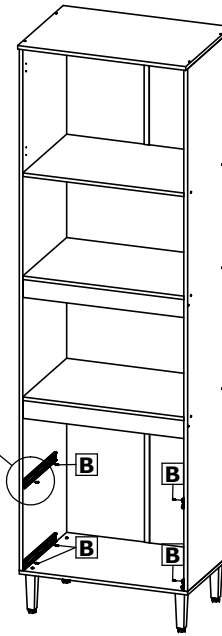
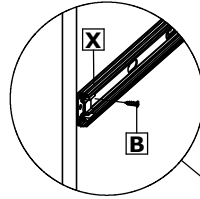

6º Passo / Step / Paso

Peso suportado/Supported weight / Peso soportado

Peso suportado por Gaveta:
Drawer supported weight:
Peso suportado cajón:

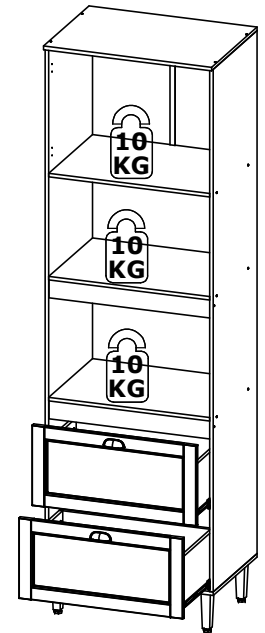

5º Passo / Step / Paso

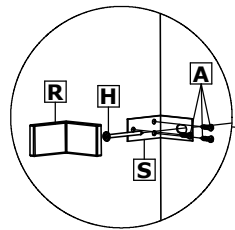

Para fixar o aéreo na parede utilizar parafusos (A), (H),
Suporte Aéreo (S), Bucha (T) e Proteção (R) /

To fix the aerial to the wall, use screws (A), (H),
Air Support (S), Bushing (T) and Protection (R) /

Para fijar la antena a la pared, utilice los tornillos (A), (H),
Air Support (S), Bushing (T) y Protección (R).

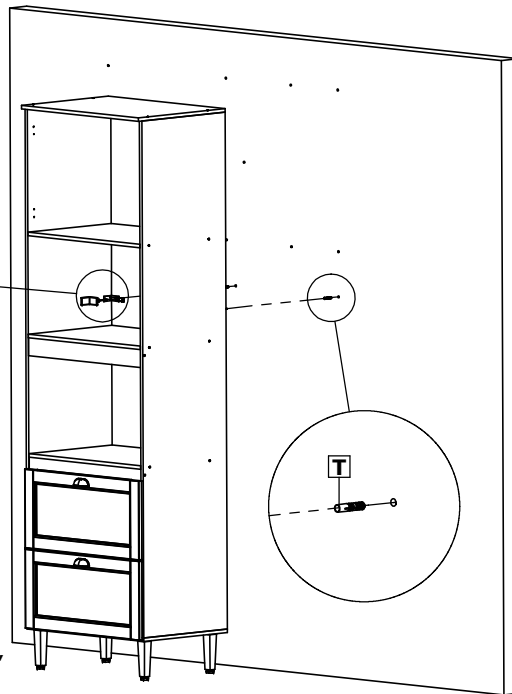

6º Passo / Step / Paso

Montagem da Porta/Door assembly/Conjunto de la puerta.

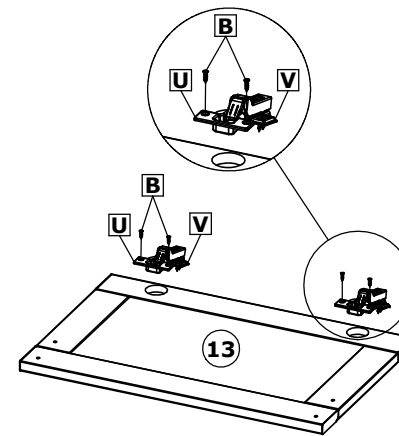

Os calços de dobradiça (U) devem ser fixados no móvel com os quatro parafusos (B),
sendo dois para regular de altura e dois para travar a porta (13) /
The hinge shims (U) must be fixed to the furniture with the four screws (B),
two to adjust the height and two to lock the door (13) /
Las cuñas de bisagra (U) deben fijarse al mueble con los cuatro tornillos (B),
siendo dos para ajustar la altura y dos para bloquear la puerta (13).

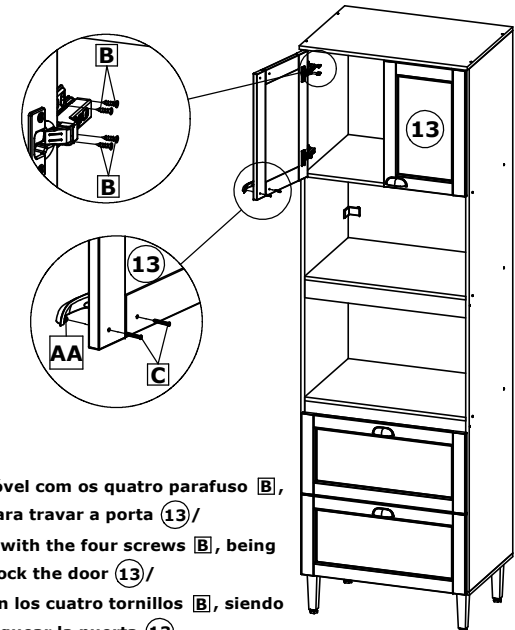



Torre Quente 2P 2Gav Cozinha Classy/ Hot Tower 2P 2Gav Classy Kitchen/ Torre Caliente Cocina Classy

Produto Montado/ Mounted Product/ Montada del producto.

Faltas especialmente por favor

Torre Quente 2P 2Gav.

