

Ao solicitar assistência informe código mais o Nº de cor. Ex: 6134.03 - 731

KIT 0,70 P/ FORNO STELLA

indêkes
Você pode viver bem

Nº	Cód:	Descrição	Medida
01	6134.03	Lat Esq	497 x 2040
02	6119.051	Chapéu	497 x 670
03	6016.025	Prateleira	497 x 670
04	6093.0126	Base Kit	497 x 670
05	6134.02	Lat. Direita	497 x 2040
06	6134.01	Forro Kit	695 x 2010
07	4221	Mold.Lat.	30 x 2040
08	4253	Mold. Horiz.	30 x 640
10	6093.099	Lat. Gav. GR	190 x 392
11	6134.09	Forro Gaveta	405 x 599
12	6134.05	Tras. Gav. GR	190 x 614
14	7228	Lat. Gav. PQ	96 x 392
15	6134.06	Tras. Gav. PQ	96 x 614

TERMO DE GARANTIA

Indêkes Indústria e Comércio de Móveis; garante este produto (por defeitos de fabricação), pelo prazo de três meses a partir da data de emissão da nota fiscal de venda do produto ao consumidor.

DADOS INDISPENSÁVEIS PARA VALIDADE DESTA GARANTIA

- 1- Forre o chão c/ papelão ou similar.
- 2- Inicie a montagem seguindo a sequência numérica "das peças".
- 3- Verifique a resistência da parede.
- 4- Fixe o corpo dos armários e paineleiros com o suporte e parafusos quando necessário.
- 5- Faça a junção com parafusos de união quando necessário.
- 6- Coloque e regule as portas e puxadores.
- 7- P/ limpeza, use pano macio e seco.
- 8- Não utilize produtos abrasivos ou similares, tais como: "CERA, ALCOL, DETERGENTES, TINNER, LUSTRA MÓVEIS, ETC".
- 9- Deixe o móvel sem uso por 24hrs p/ dar rigidez a estrutura.
- 10- Produto para uso doméstico.
- 11- Cumprindo todos os requisitos existentes nesse Certificado de Garantia, o seu produto estará coberto pela GARANTIA DE 90 DIAS.

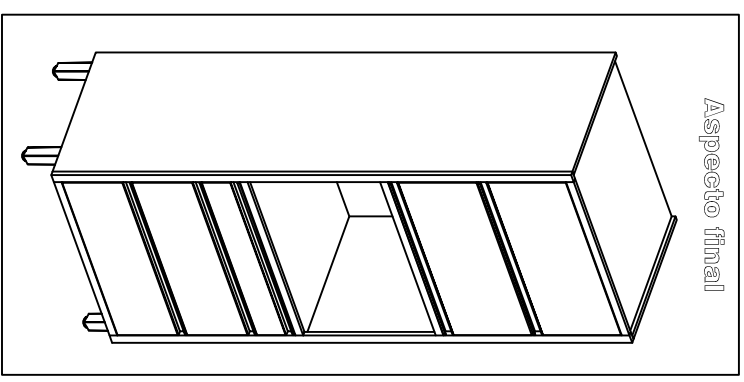
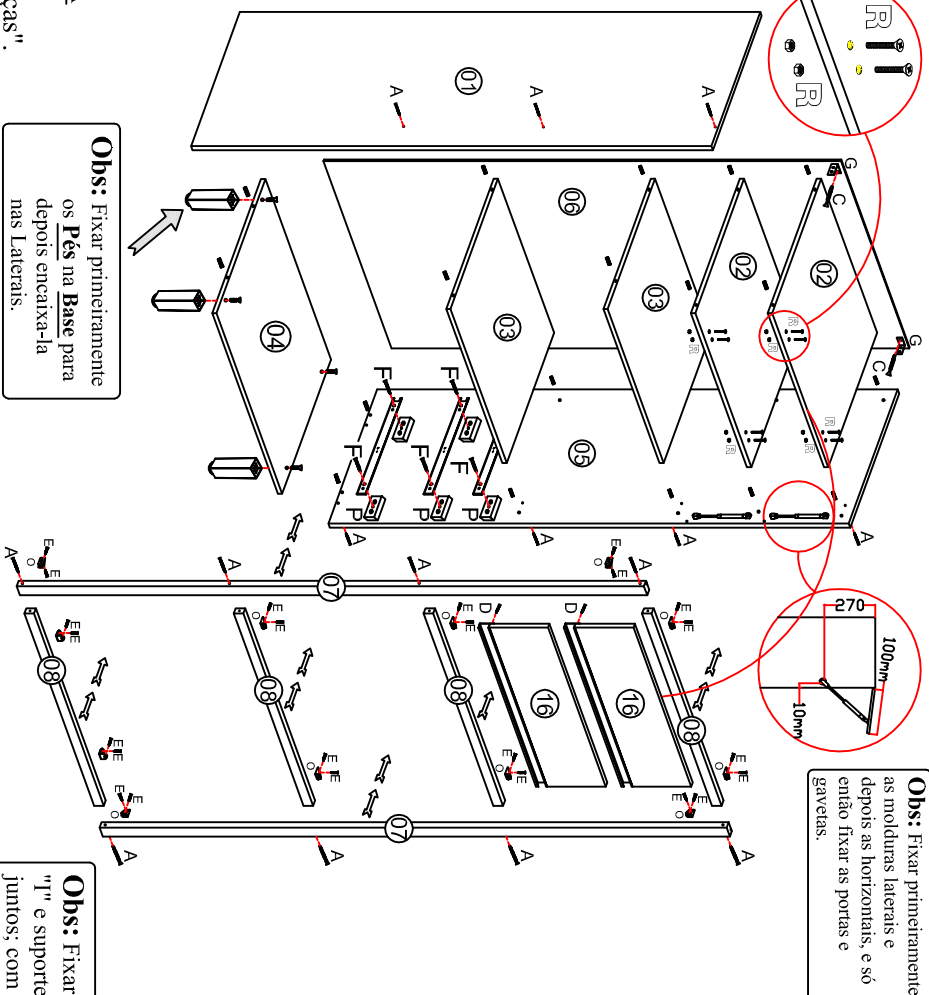











































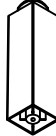
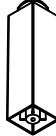



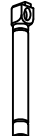

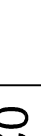
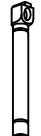

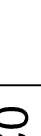

































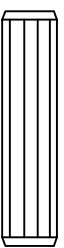

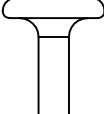
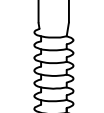
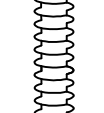
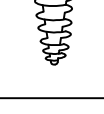
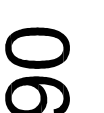
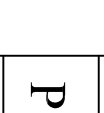
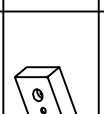
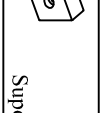

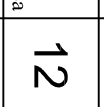
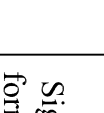
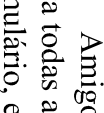
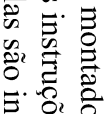
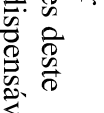
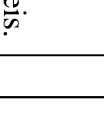

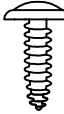
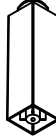

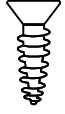

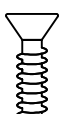
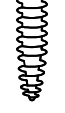



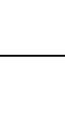
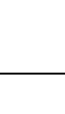



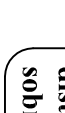
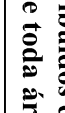
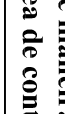
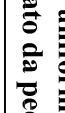

Nº	Cód:	Opções de Portas e Cores
16	6134.04	Porta base 345 x 636
09	6134.07	Front. Gav GR 262 x 636
13	6134.08	Front. Gav PQ 168 x 636

Off-white

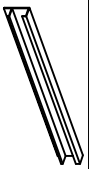
Rua bom Jesus, 08 - Parque Industrial
Fone / Fax (045) 3286-7400
CEP 85790-000 - Capitão L. Marques - PR
www.indêkes.com.br

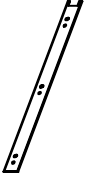
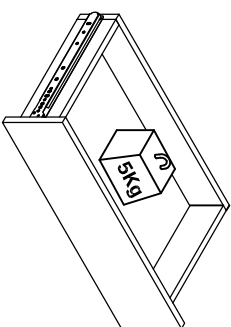
ACESSÓRIOS

A	                   	Montagem/Estrutura	3,5x50mm	34	K	         	Dobradiça	04
L		Cola	Usar nas cavilhas	02	L			02
M		Bucha de Fixação		02	M			02
N		Pé plástico		04	N			04
O		Cantoneira Angular		16	O			16
P		Suporte p/ corredeira		12	P			12
Q	  	Pistão 60NW Cod:(1895)		02	Q	  		02
R	 	Paraf. com porca		08	R	 		08
A	                   	Montagem/Estrutura	3,5x50mm	34	K	         	Dobradiça	04
B		Cavilha	8x30mm	44	L		Usar nas cavilhas	02
C	                	Pfuso Pés/Parede	4.8 x 55mm	06	M		Bucha de Fixação	02
D	 	Puxadores	3,5x14mm	15	N		Pé plástico	04
E	 	Dobradiças	Cantoneiras	73	O		Cantoneira Angular	16
F	                	Pfuso União	4,5 x 28mm	14	P		Suporte p/ corredeira	12
G		Suporte de fixação Capa Plástica		01	Q	 	Pistão 60NW Cod:(1895)	02
H		Puxador		05	R	 	Paraf. com porca	08
I		Corredeira Cetel		3par				
J		Cantoneira 2 furos		08				

Obs: É indispensável pregar o forro traseiro nas prateleiras.

Notas: A separação dos acessórios antes de iniciar a montagem facilitará a mesma. Os parafusos e cavilhas estão na escala real. Em caso de dúvida na identificação, coloque o acessório sobre a imagem.

Amigo montador
Siga todas as instruções deste formulário, elas são indispensáveis. Lembre-se : A indústria não se responsabiliza por danos na hora da montagem

CARGA SUPORTAVEL
O peso máximo de carga informado no desenho ao lado refere-se a objetos distribuídos de maneira uniforme sobre toda área de contato da peça

Atenção: É obrigatório a fixação do Pannelero na parede; (não nos responsabilizamos por eventuais acidentes).

Aspecto final

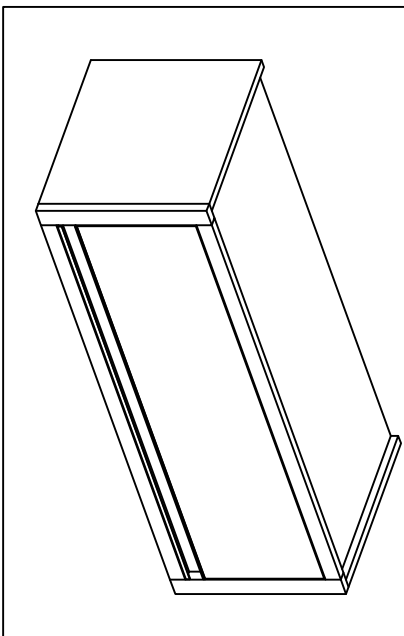

ARM. GEL. 0,80 BASC STELLA

Opções de Portas e Cores

Nº Cód:

Off-White

08	Porta Basic 271 x 736 6134.053	764
----	--------------------------------------	-----

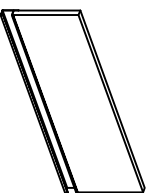

TERMO DE GARANTIA

Indekes Indústria e Comércio de Móveis; garante este produto (por defeitos de fabricação), pelo prazo de três meses a partir da data de emissão da nota fiscal de venda do produto ao consumidor.

DADOS INDISPENSÁVEIS PARA VALIDADE DESTA GARANTIA

- 1- Forre o chão c/ papelão ou similar.
- 2- Inicie a montagem seguindo a sequência numérica.
- 3- Verifique a resistência da parede.
- 4- Fixe o corpo dos armários e paineleiros com o suporte e parafusos quando necessário.
- 5- Faça a junção com parafusos de união quando necessário.
- 6- Coloque e regule as portas e puxadores.
- 7- P/ limpeza, use pano macio e seco.
- 8- Não utilize produtos abrasivos ou similares, tais como: "CERA, ÁLCOOL, DETERGENTES, TINNER, LUSTRA MÓVEIS, ETC".
- 9- Deixe o móvel sem uso por 24hrs p/ dar rigidez a estrutura.
- 10- Produto para uso doméstico.
- 11- Cumprindo todos os requisitos existentes nesse Certificado de Garantia, o seu produto estará coberto pela GARANTIA DE 90 DIAS.





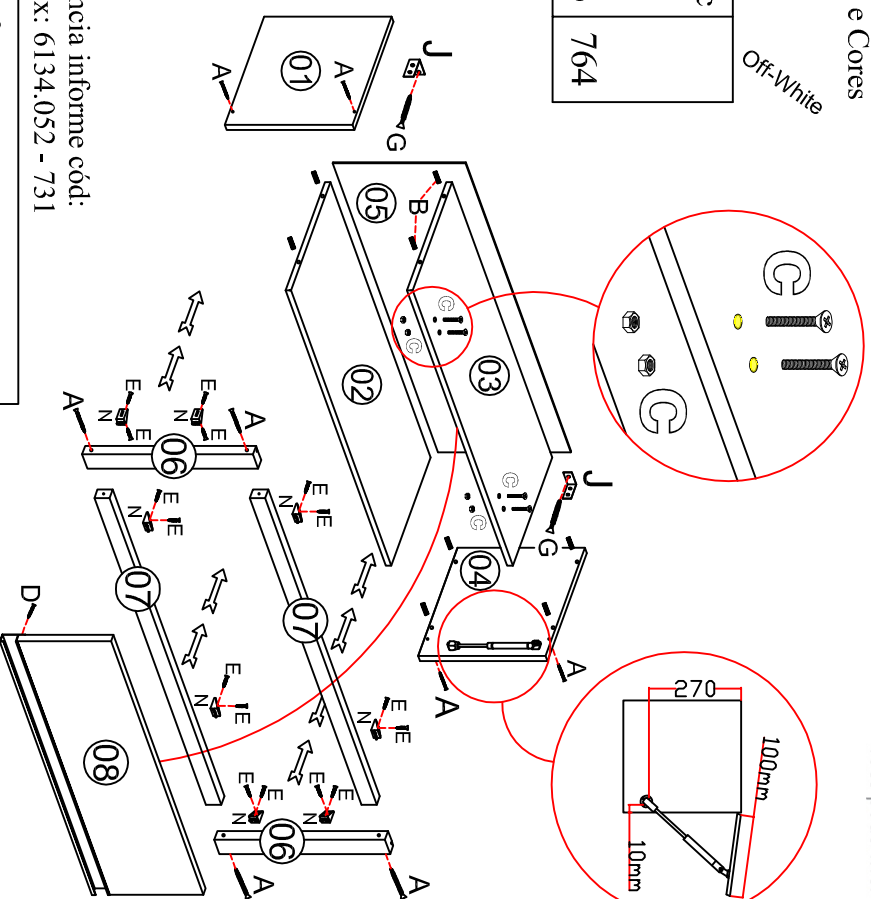

Ao solicitar assistência informe cód: mais o Nº de cor. Ex: 6134.052 - 731





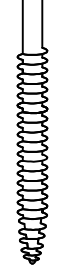

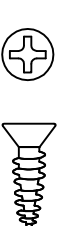
Nº	Cód:	Nome	Descrição	Medida
01	6134.052	731	Lat. Esq. Ar	300 x 335
02	227	731	Base Inf	300 x 770
03	1169	731	Chapéu Ar	300 x 770
04	6134.051	731	Lat. Dir. Ar	300 x 335
05	6134.050	731	Forro Ar	280 x 795
06	4211		Moldura Lat.	30 x 335
07	4206		Moldura Horiz.	30 x 740

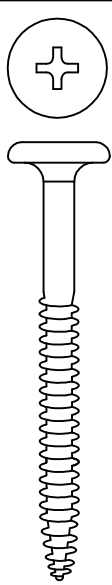
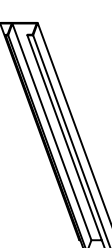

Obs:
Fixar primeiramente as molduras laterais e depois as horizontais, e só então fixar as portas

ACESSÓRIOS

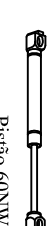
A	 Montagem/Estrutura 3,5x50mm	08
B	 Cavilha 8x30mm	08
C	 4.0x25mm Paraf. com porca	04
D	 3,5x14mm Paraf. Flangeado p/ puxadores	03
E	 Dobradiças Cantoneiras 3,5x14mm	20
F	 Pfuso União 4,5 x 28mm	03
G	 Pfuso Pés/Parede 4.8 x 55mm	02
H	 Puxador	01

I	 Buca de fixação	02
J	 Suporte de fixação Capa Plástica	02
K	 Calço Dobradiça	02
L	 Cola Usar nas cavilhas	01
M	 Pistão 60NW Cod.(1895)	01
N	 Cantoneira Angular	08

CARGA SUPORTAVEL
O peso máximo de carga informado no desenho abaixo refere-se a objetos distribuídos de maneira uniforme sobre toda área de contato da peça

Notas: A separação dos acessórios antes de iniciar a montagem facilitará a mesma. Os parafusos e cavilhas estão na escala real. Em caso de dúvida na identificação, coloque o acessório sobre a imagem.

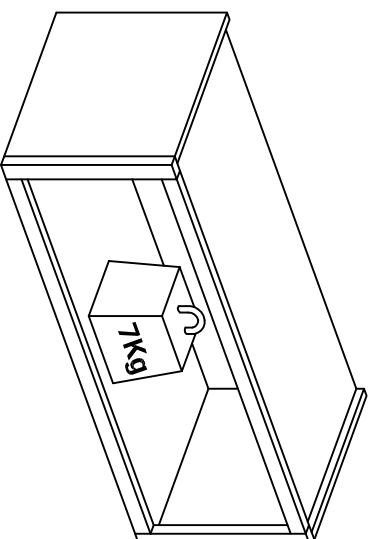

Amigo montador
Siga todas as instruções deste formulário, elas são indispensáveis.
Lembre-se : A indústria não se responsabiliza por danos na hora da montagem

Aspecto final

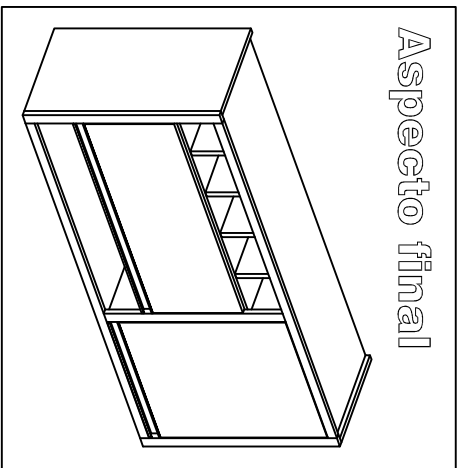

ARMÁRIO 1,20 STELLA

Amigo montador
Siga todas as instruções deste formulário, elas são indispensáveis.
Lembre-se : A indústria não se responsabiliza por danos na hora da montagem

Obs:
Fixar primeiramente as molduras laterais e depois as horizontais, e só então fixar as portas

Obs: Usar dobradiças superalta com amortecedor na porta lateral direita.

Obs: É indispensável pregar o forro traseiro na prateleira e divisória do Armário.

TERMO DE GARANTIA
Indêkes Indústria e Comércio de Móveis; garante este produto (por defeitos de fabricação), pelo prazo de três meses a partir da data de emissão da nota fiscal de venda do produto ao consumidor.

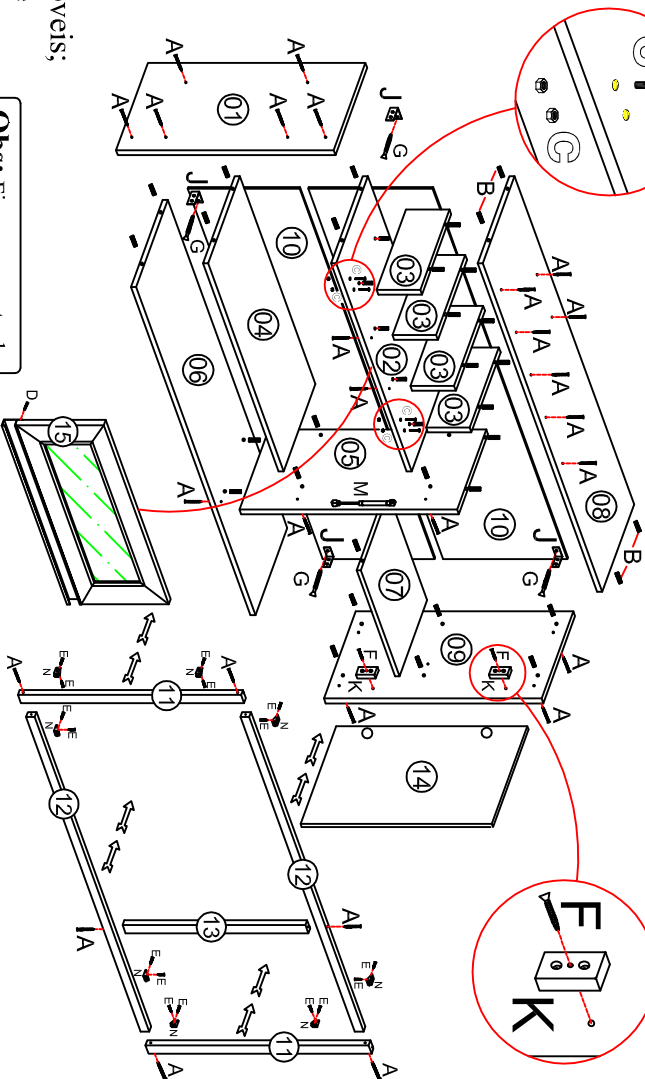

Obs: Fixar o suporte do calço "K" com parafuso "F" no furo central do suporte com a marcação indicada na lateral

DADOS INDISPENSÁVEIS PARA VALIDADE DESTA GARANTIA

- 1- Forre o chão c/ papelão ou similar.
- 2- Inicie a montagem seguindo a sequência numérica "das peças".
- 3- Verifique a resistência da parede.
- 4- Fixe o corpo dos armários e paineleiros com o suporte e parafusos quando necessário.
- 5- Faça a junção com parafusos de união quando necessário.
- 6- Coloque e regule as portas e puxadores.
- 7- P/ limpeza, use pano macio e seco.
- 8- Não utilize produtos abrasivos ou similares, tais como: "CERA, ÁLCOOL, DETERGENTES, TINNER, LUSTRA MÓVEIS, ETC".
- 9- Deixe o móvel sem uso por 24hrs p/ dar rigidez a estrutura.
- 10- Produto para uso doméstico.
- 11- Cumprindo todos os requisitos existentes nesse Certificado de Garantia, o seu produto estará coberto pela GARANTIA DE 90 DIAS.

Op: de Portas e Cores













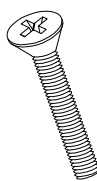

Nº	Cód:	Off-White
14	6134.041	764
15	4223	764

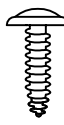



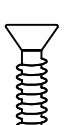
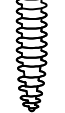

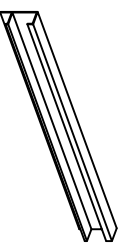

Ao solicitar assistência informe o cód: mais o N° de cor. Ex: 6134.034 - 731

Nº	Cód:	Noce	Descrição	Medida
01	6134.034	731	Lateral Esq	300 x 670
02	6134.037	731	Base Adega	300 x 729
03	6134.040	731	Div. Adega	130 x 298
04	6134.038	731	Prat. Inferior	300 x 729
05	6134.036	731	Divisória Ar	300 x 590
06	6134.033	731	Base Ar.	300 x 1170
07	6134.039	731	Prateleira Ar	240 x 426
08	6134.032	731	Chapéu Ar	300 x 1170
09	6134.035	731	Lateral Dir.	300 x 670
10	527	731	Forro Ar.	301 x 1195
11	4220		Mold. Vert.	30 x 670
12	4208		Mold. Horiz.	30 x 1140
13	4210		Mold. Central	30 x 610

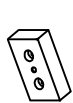
Rua bom Jesus, 08 - Parque Industrial
Fone / Fax (045) 3286-7400
CEP 85790-000 - Capitão L. Marques - PR
www.indêkes.com.br

ACESSÓRIOS

A	   Montagem/Estrutura 3,5x50mm	34
B	 Cavilha 8x30mm	40
C	  4.0x25mm Paraf. com porca	04
D	  3,5x14mm Paraf. Flangeado p/ puxadores	05
E	  3,5x14mm Dobradiças Cantoneiras	36
F	   Pfuso União 4,5 x 28mm	09
G	   Pfuso Pés/Parede 4.8 x 55mm	04
H	 Puxador	02

I	 Buca de fixação	04
J	 Suporte de fixação Capa Plástica	04
K	 Suporte p/ calço	02
L	 Cola Usar nas cavilhas	02
M	 Pistão 80NW Cod.(2261)	01
N	 Cantoneira Angular	10
O	  Calço Dobradiça	04

CARGA SUPORTAVEL
O peso máximo de carga informado no desenho abaixo refere-se a objetos distribuídos de maneira uniforme sobre toda área de contato da peça

Notas: A separação dos acessórios antes de iniciar a montagem facilitará a mesma. Os parafusos e cavilhas estão na escala real. Em caso de dúvida na identificação, coloque o acessório sobre a imagem.

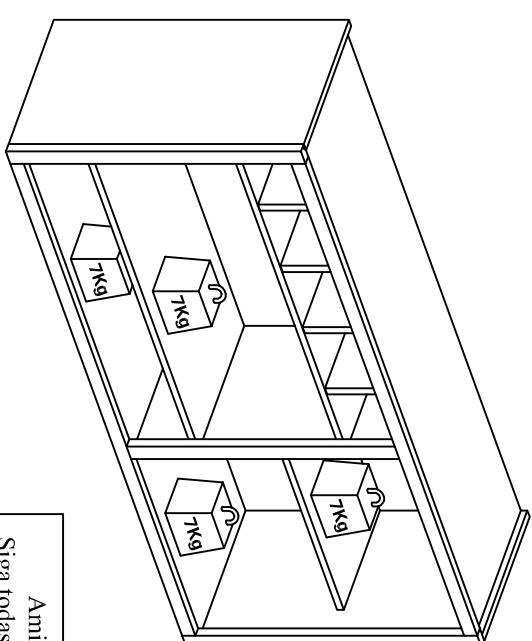

Amigo montador
Siga todas as instruções deste formulário, elas são indispensáveis.
Lembre-se : A indústria não se responsabiliza por danos na hora da montagem

Aspecto Final

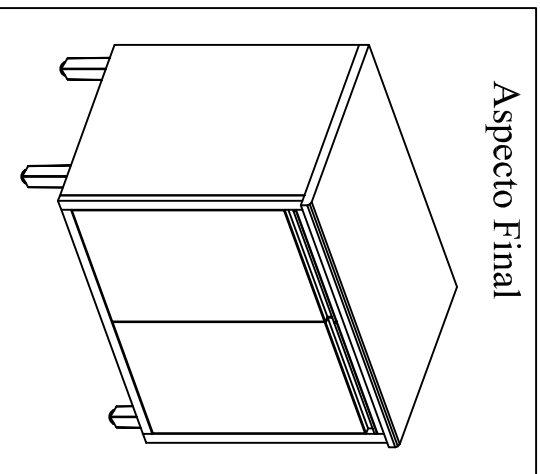

BALCÃO 0,80 STELLA

Indêkes
você pode viver bem

Opções de cores e Tampo

Nº	Cód:	Noce	Descrição	Medida
06	918	731	Tampo	530 x 800

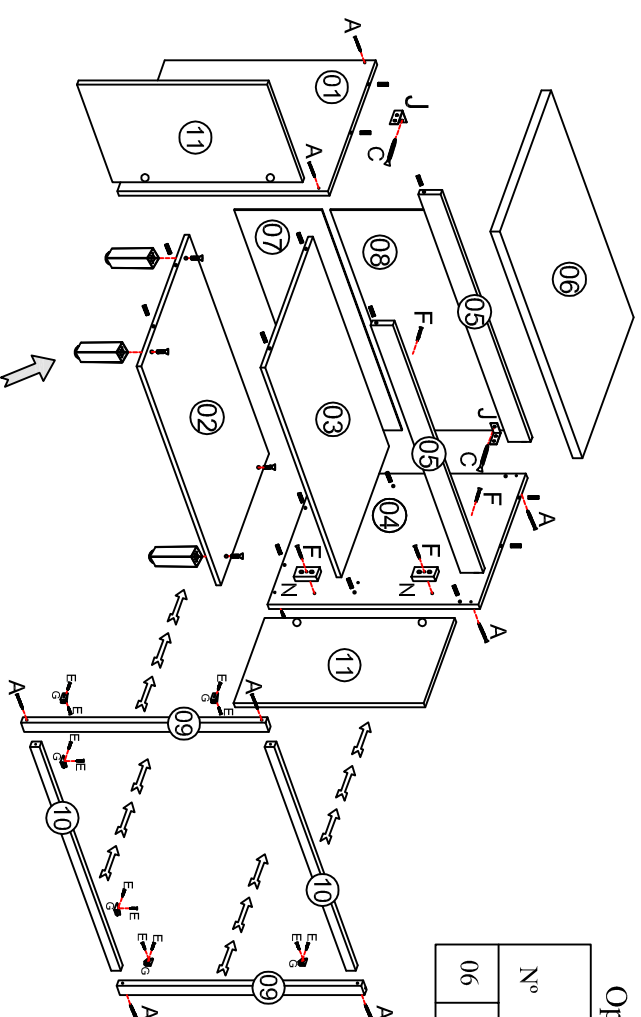

Obs:
Fixar primeiramente as molduras laterais e depois as horizontais, e só então fixar as portas

TERMO DE GARANTIA
Indêkes Indústria e Comércio de Móveis,, garante este produto (por defeitos de fabricação), pelo prazo de três meses a partir da data de emissão da nota fiscal de venda do produto ao consumidor.

DADOS INDISPENSÁVEIS PARA VALIDADE DESTA GARANTIA

- 1- Forre o chão c/ papelão ou similar.
- 2- Inicie a montagem seguindo a sequência numérica "das peças".
- 3- Verifique a resistência da parede.
- 4- Fixe o corpo dos armários e paineleiros com o suporte e parafusos quando necessário.
- 5- Faça a junção com parafusos de união quando necessário.
- 6- Coloque e regule as portas e puxadores.
- 7- P/ limpeza, use pano macio e seco.
- 8- Não utilize produtos abrasivos ou similares, tais como: "CERA, ÁLCOOL, DETERGENTES, TINNER, LUSTRA MÓVEIS, ETC".
- 9- Deixe o móvel sem uso por 24hrs p/ dar rigidez a estrutura.
- 10- Produto para uso doméstico.
- 11- Cumprindo todos os requisitos existentes nesse Certificado de Garantia, o seu produto estará coberto pela GARANTIA DE 90 DIAS.

Obs: Fixar primeiramente os **Pés** na **Base** para depois encaixa-la nas Laterais.

Opções de Portas e Cores

Nº	Cód:	Off White
11	6134.047	764
	Porta BL	
	367 x 693	







Obs: É indispensável pregar o forro traseiro no Tampo e Prateleira.



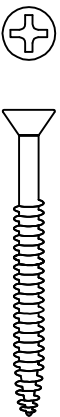
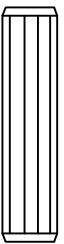
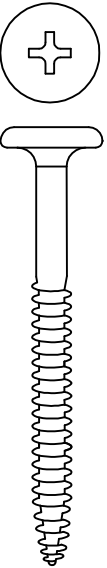



Ao solicitar assistência informe
Cód: mais o Nº de cor. Ex: 6134.045

Nº	Cód:	Noce	Descrição	Medida
01	6134.045	731	Lateral Esq	497 x 760
02	6093.079	731	Base BL	497 x 770
03	6093.080	731	Prateleira	497 x 770
04	6134.044	731	Lat Direita	497 x 760
05	367	731	Vista BL	70 x 770
07	6093.077	731	Forro Menor	335 x 795
08	6093.081	731	Forro Maior	430 x 795
09	4207	731	Mold. Lateral	30 x 760
10	4276	731	Mold. Horiz.	30 x 740

Rua bom Jesus, 08 - Parque Industrial
Fone / Fax (045) 3286-7400
CEP 85790-000 - Capitão L. Marques - PR
www.indêkes.com.br

ACESSÓRIOS

A		Montagem/Estrutura	3,5x50mm
	14		
B		Cavilha	8x30mm
	16		
C		Pfuso Parede	4.8 x 55mm
	06		
D		Paraf. Flangeado	3,5x14mm
	04		
E		Dobradiças	3,5x14mm
	32		
F		Pfuso União	4,5 x 28mm
	17		
G		Cantoneira Angular	06
	02		
H		Puxador	02

I		Pé plástico	04
J		Supporte de fixação Capa Plástica	02
K		Calço Dobradiça	04
L		Cola	01
M		Bucha de Fixação	02
N		Supporte p/ calço	04
O		Cantoneira 2 furos	04

Notas: A separação dos acessórios antes de iniciar a montagem facilitará a mesma. Os parafusos e cavilhas estão na escala real. Em caso de dúvida na identificação, coloque o acessório sobre a imagem.

Obs: É indispensável pregar o forro traseiro na prateleira.

CARGA SUPORTAVEL
O peso máximo de carga informado no desenho ao lado refere-se a objetos distribuídos de maneira uniforme sobre toda área de contato da peça

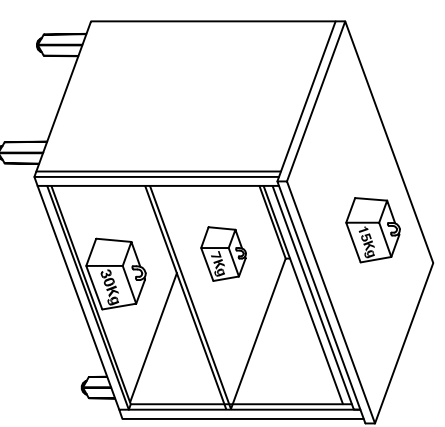

Amigo montador
Siga todas as instruções deste formulário, elas são indispensáveis.
Lembre-se : A indústria não se responsabiliza por danos na hora da montagem.

BALCÃO 1,20 3P 2G STELLA

Aspecto final

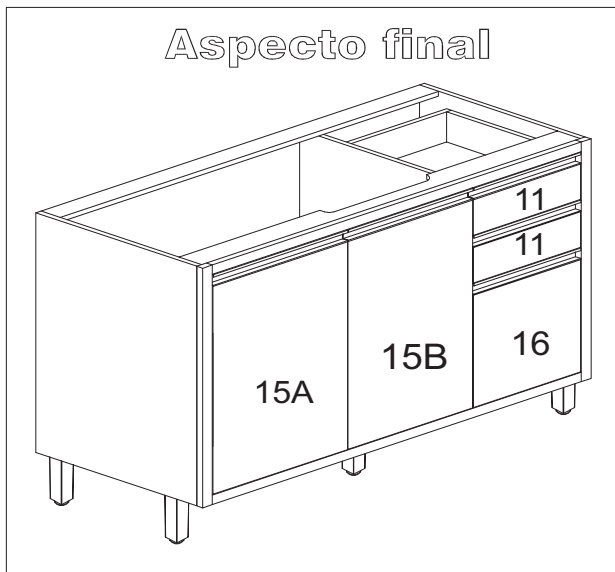

TERMO DE GARANTIA

Indekes Indústria e Comércio de Móveis., garante este produto (por defeitos de fabricação), pelo prazo de três meses a partir da data de emissão da nota fiscal de venda do produto ao consumidor.

DADOS INDISPENSÁVEIS PARA VALIDADE DESTA GARANTIA

- 1- Forre o chão c/ papelão ou similar.
- 2- Inicie a montagem seguindo a sequência numérica "das peças".
- 3- Verifique a resistência da parede.
- 4- Fixe o corpo dos armários e paineleiros com o suporte e parafusos quando necessário.
- 5- Faça a junção com parafusos de união quando necessário.
- 6- Coloque e regule as portas e puxadores.
- 7- P/ limpeza, use pano macio e seco.
- 8- Não utilize produtos abrasivos ou similares, tais como: "CERA, ÁLCOOL, DETERGENTES, TINNER, LUSTRA MÓVEIS, ETC".
- 9- Deixe o móvel sem uso por 24hrs p/ dar rigidez a estrutura.
- 10- Produto para uso doméstico.
- 11- Cumprindo todos os requisitos existentes nesse Certificado de Garantia, o seu produto estará coberto pela GARANTIA DE 90 DIAS.

Rua bom Jesus, 08 - Parque Industrial
Fone / Fax (045) 3286-7400
CEP 85790-000 - Capitão L. Marques - PR
www.indekes.com.br

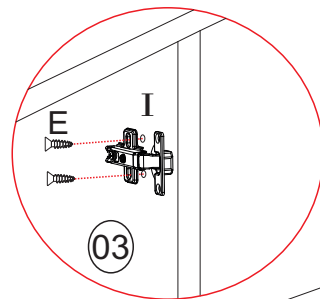

OBS : DOBRADIÇA ALTA (I) FIXAR NA DIVISORIA PEÇA Nº 03 QUE VAI SEPARADO NOS ACESSÓRIOS.

OBS: FIXAR A CORREDIÇA (H) NO SUPORTE P/ CALÇO (N) SEM USAR TODA A ROSCA DO PARAFUZO DEIXANDO APENAS UM APONTAMENTO PARA NA SEQUENCIA POSICIONAR NAS MARCAÇÕES DA LATERAL DO BALCÃO ASSIM FIXANDO A CORREDIÇA E O CALÇO NA LATERAL QUE POSSUI MOLDURA.

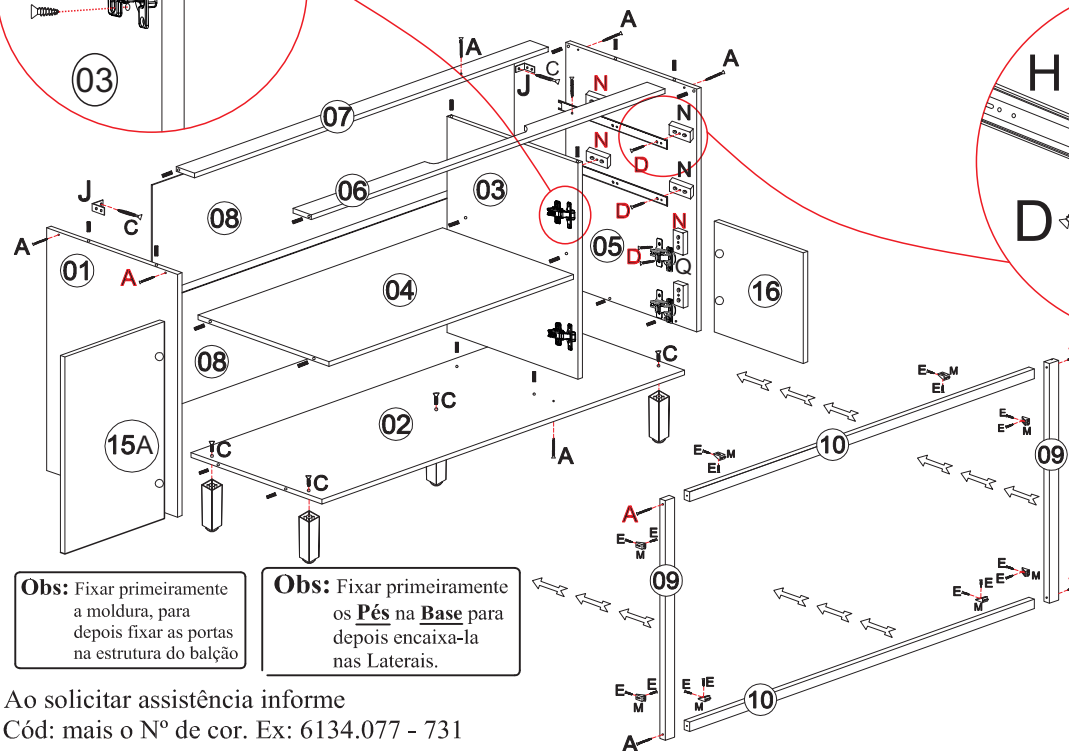
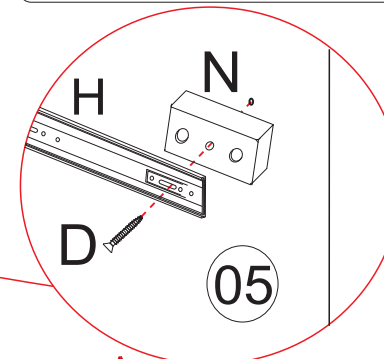

Obs: Fixar primeiramente a moldura, para depois fixar as portas na estrutura do balcão

Obs: Fixar primeiramente os Pés na Base para depois encaixa-la nas Laterais.

OBS: APOS FIXAR DOBRADIÇA (O) NA PORTA (15A) E (16) FIXAR A DOBRADIÇA (O) NO SUPORTE P/ CALÇO (N) SEM USAR TODA A ROSCA DO PARAFUZO DEIXANDO APENAS UM APONTAMENTO PARA NA SEQUENCIA POSICIONAR NAS MARCAÇÕES DA LATERAL DO BALCÃO ASSIM FIXANDO A DOBRADIÇA E O CALÇO NA LATERAL QUE POSSUI MOLDURA.

Ao solicitar assistência informe
Cód: mais o Nº de cor. Ex: 6134.077 - 731



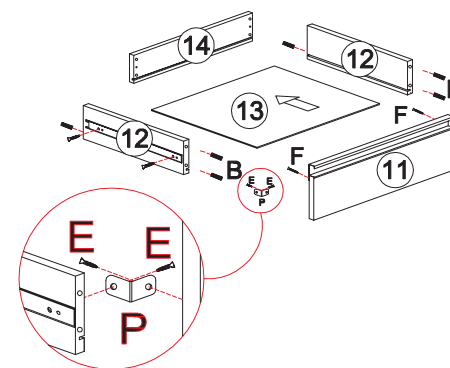

Nº	Cód:	Moço	Descrição	Medida
01	6134.077	731	Lateral Esq.	497 x 760
02	6118.013	731	Base BL	497 x 1170
03	6134.014	731	Divisória BL	497 x 730
04	6134.013	731	Prateleira	497 x 794
05	6134.012	731	Lateral Dir..	497 x 760
06	6093.073	731	Vista Frontal	60 x 1168
07	6093.0121	731	Vista Tras.	51 x 1168
08	6093.067	731	Forro BL	377 x 1197
09	4207		Mold. Lateral	30 x 760
10	4263		Mold. Horiz.	30 x 1140
12	7228	731	Lat. Gaveta	96 x 392
13	6134.017	731	Forro Gav.	304 x 402
14	6134.016	731	Traseiro Gav.	96 x 320





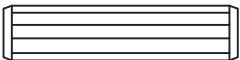
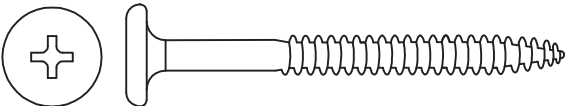





Opções de Portas/Gavetas e Cores

Nº	Cod:	Off-white
11	Frent Gav 168 x 348 6134.020	764
	Porta BL 389 x 696	
15	6134.018	764
	Porta Menor 356 x 348	
16	6134.019	764

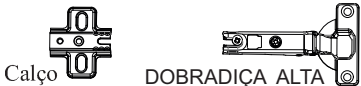
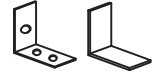
ACESSÓRIOS

A	 Montagem/Estrutura 3,5x50mm	22
B	 Cavilha 8x30mm	36
C	 Pfuso Parede 4.8 x 55mm	07
D	 Pfuso União/calço 4,5 x 28mm	27
E	 Dobradiças Cantoneiras 3,5x14mm	56
F	 3,5x14mm Paraf. Flangeado p/ puxadores	10

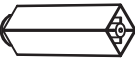
G	 Puxador	05
H	 CORREDIÇA TELESCÓPICA	2Par

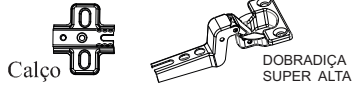
I	 Calço DOBRADIÇA ALTA	02
J	 Suporte de fixação Capa Plástica	02
K	 Cola Usar nas cavilhas	02
L	 Bucha de Fixação	02
M	 Cantoneira Angular	08
N	 SUPORTE P/ CALÇO E CORREDIÇAS	08
O	 Pé plástico	05
P	 Cantoneira 2 furos	04
Q	 Calço DOBRADIÇA SUPER ALTA	04

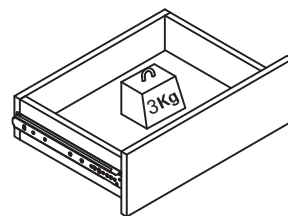

Obs: É indispensável pregar o forro traseiro na prateleira central.

Notas: A separação dos acessórios antes de iniciar a montagem facilitará a mesma. Os parafusos e cavilhas estão na escala real. Em caso de dúvida na identificação, coloque o acessório sobre a imagem.

CARGA SUPORTAVEL

O peso máximo de carga informado no desenho ao lado refere-se a objetos distribuídos de maneira uniforme sobre toda área de contato da peça

Amigo montador

Siga todas as instruções deste formulário, elas são indispensáveis. Lembre-se : A indústria não se responsabiliza por danos na hora da montagem.

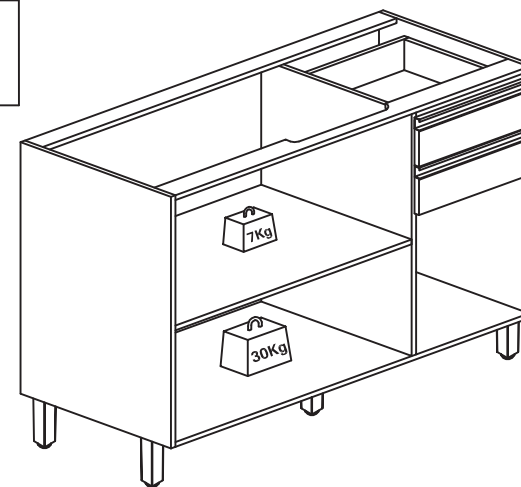

Ao solicitar assistência informe código mais o N° de cor. Ex: 6134.0119 - 731

PANEELEIRO 0,50 STELLA

indêkes
Você pode viver bem

N°	Cód:	Descrição	Medida
01	6134.0119	Lat Esq PN	497 x 2040
02	6134.0114	Base PN	497 x 470
03	6134.0115	Chapéu/Prat	497 x 470
04	6134.0117	Prateleira	470 x 430
05	6134.0113	Lat. Direita	497 x 2040
06	6134.0112	Forro PN	497 x 2010
07	4221	Mold. Lat.	30 x 2040
08	4396	Mold. Horiz.	30 x 440

TERMO DE GARANTIA

Indêkes Indústria e Comércio de Móveis; garante este produto (por defeitos de fabricação), pelo prazo de três meses a partir da data de emissão da nota fiscal de venda do produto ao consumidor.

DADOS INDISPENSÁVEIS PARA VALIDADE DESTA GARANTIA

- 1- Forre o chão c/ papelão ou similar.
- 2- Inicie a montagem seguindo a sequência numérica "das peças".
- 3- Verifique a resistência da parede.
- 4- Fixe o corpo dos armários e paineleiros com o suporte e parafusos quando necessário.
- 5- Faça a junção com parafusos de união quando necessário.
- 6- Coloque e regule as portas e puxadores.
- 7- P/ limpeza, use pano macio e seco.
- 8- Não utilize produtos abrasivos ou similares, tais como: "CERA, ALCOL, DETERGENTES, TINNER, LUSTRA MÓVEIS, ETC".
- 9- Deixe o móvel sem uso por 24hrs p/ dar rigidez a estrutura.
- 10- Produto para uso doméstico.
- 11- Cumprindo todos os requisitos existentes nesse Certificado de Garantia, o seu produto estará coberto pela GARANTIA DE 90 DIAS.

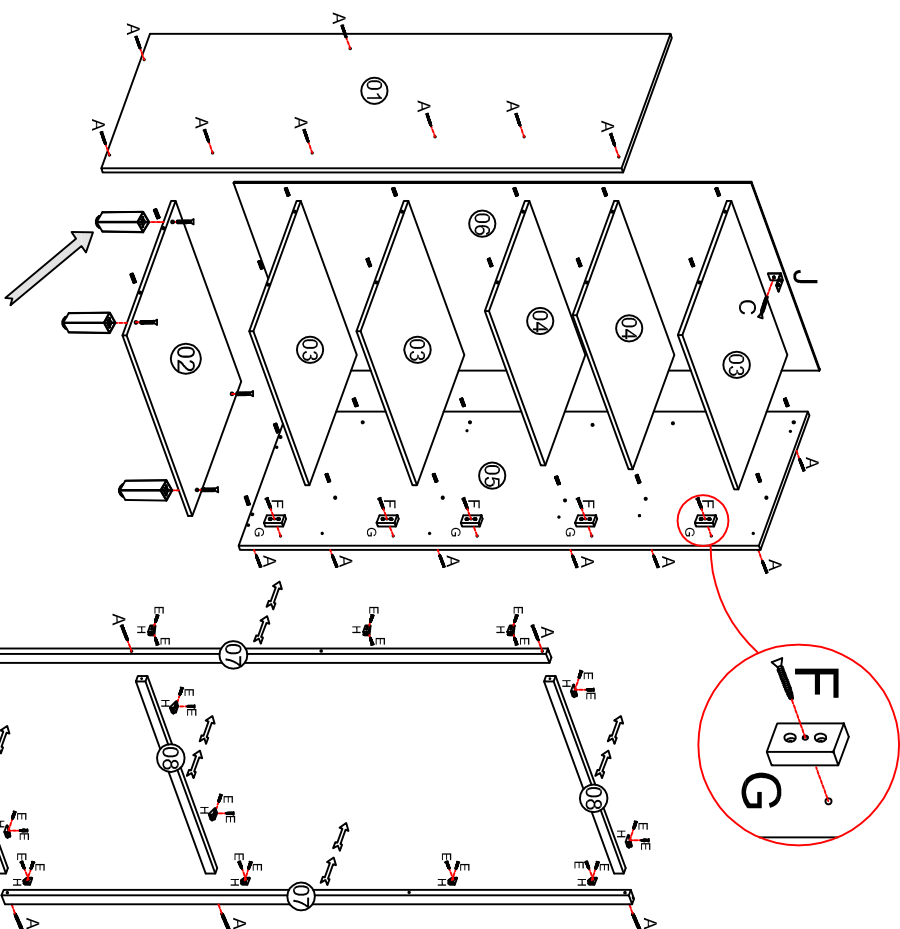

Obs: Fixar primeiramente os **Pés** na **Base** para depois encaixa-la nas Laterais.

Obs: É indispensável pregar o forro traseiro nas prateleiras.

Obs: Fixar primeiramente as molduras laterais e depois as horizontais, e só então fixar as portas.

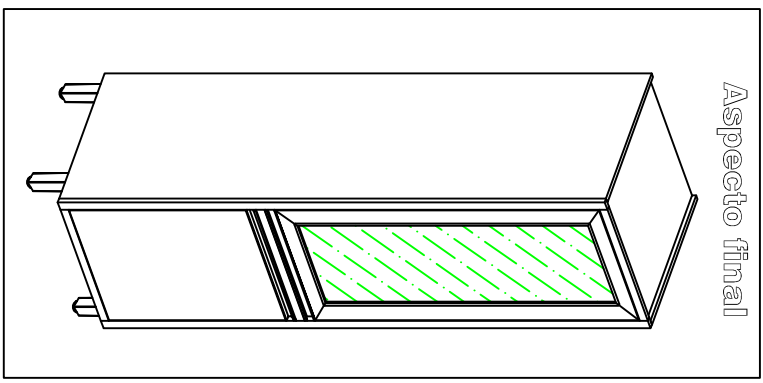

Aspecto final

Opções de Portas e Cores
Off-white

N°	Cód:	Porta	Cód:
09	6134.0118	Porta Inf. 434 x 693	764
10	4363	Porta vid 434 x 1244	764

Rua bom Jesus, 08 - Parque Industrial
Fone / Fax (045) 3286-7400
CEP 85790-000 - Capitão L. Marques - PR
www.indêkes.com.br

ACESSÓRIOS



05

K

Calço



Usar nas cavilhas

02

L



Bucha de Fixação

01

M

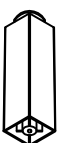

Pé plástico

04

N

Notas: A separação dos acessórios

antes de iniciar a montagem facilitará a mesma. Os parafusos e cavilhas estão na escala real. Em caso de dúvida na identificação, coloque o acessório sobre a imagem.

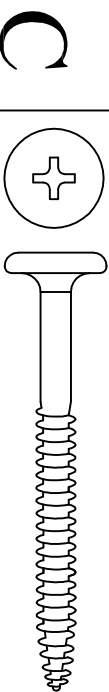

05

C

Pifuso Pés/Parede 4.8 x 55mm



06

D

Puxadores 3,5x14mm



40

E

Dobradiças Cantoneiras 3,5x14mm

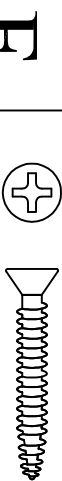

18

F

Pifuso União 4,5 x 28mm



05

G

Suporte p/ correção



14

H

Cantoneira Angular



02

I

Puxador



01

J

Suporte de fixação Capa Plástica

Obs: É indispensável pregar o forro traseiro nas prateleiras.

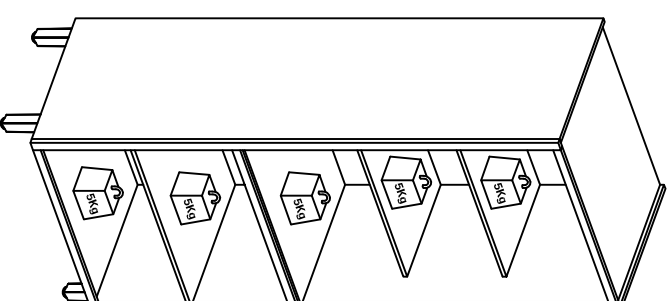

Amigo montador

Siga todas as instruções deste formulário, elas são indispensáveis. Lembre-se : A indústria não se responsabiliza por danos na hora da montagem

CARGA SUPORTAVEL

O peso máximo de carga informado no desenho ao lado refere-se a objetos distribuídos de maneira uniforme sobre toda área de contato da peça

Atenção: É obrigatório a

fixação do Panneliro na parede; (não nos responsabilizamos por eventuais acidentes).