

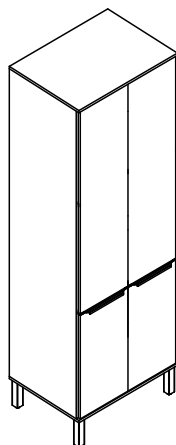

Rodovia SC-492 - Km 10 - B. Industrial  
89905-000 - Bandeirante - SC  
Fone: (49) 3622-4549  
e-mail: mxmoveis@mxmoveis.com.br



**Ref. PVE02**

**Paneleiro 4P**  
**Armario p/Ollas 4P**  
**Cozinha/Cocina**  
**Verace**

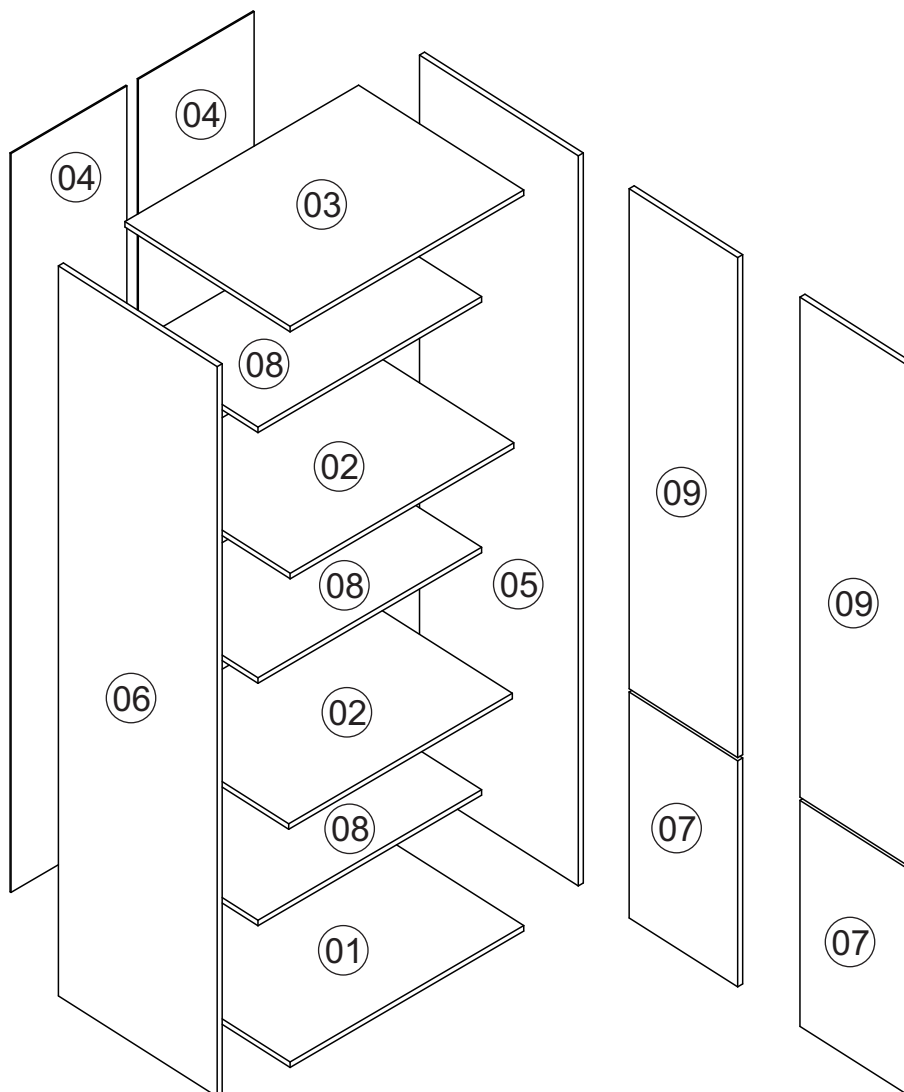

Nº	CÓDIGO ASSISTÊNCIA	NOME DA PEÇA/DESCRIPCIÓN PIEZAS	MEDIDAS (mm)	QTD.	CÓDIGO DAS PEÇAS/CÓDIGO PIEZAS						
					HAVANA	TAUPE	TAUPE	OFF WHITE	TITANIO	TAUPE	
01	PVE02.01.00	Base inferior/Base inferior	700x516x15	01	66145		66201			54085	
02	PVE02.02.02	Base interna/Base	670x496x15	02	93366		93211			54086	
03	PVE02.05.00	Base superior/Base superior	700x516x15	01	10839		107016			54087	
04	PVE02.13.00	Forro/Revés	2014x347x2.5	02	64586		64586			47486	
05	PVE02.17.00	Lateral externa direita/Lateral derecha	1990x496x15	01	64587		64609			54088	
06	PVE02.18.00	Lateral externa esquerda/Lateral izquierda	1990x496x15	01	64588		64610			54089	
07	PVE02.25.01	Porta panel/Puerta	616x339x15	02		64589		64611			54078
08	PVE02.27.00	Prateleira interna/Repisa	670x400x15	03	64590		64590			47490	
09	PVE02.25.00	Porta panel/Puerta	1363x339x15	02		64591		64612			54079

# Ferragens/Herrajes

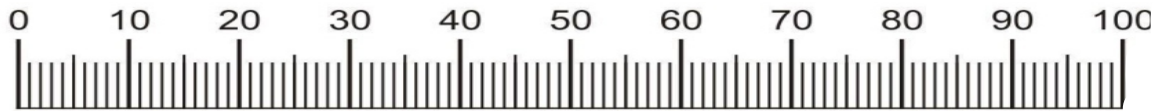
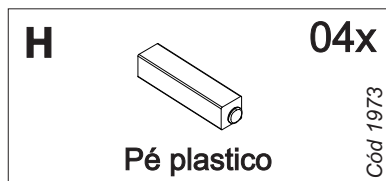
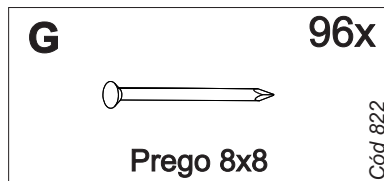
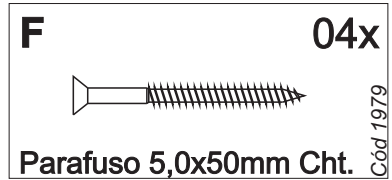
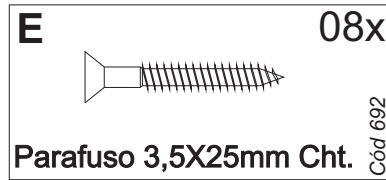
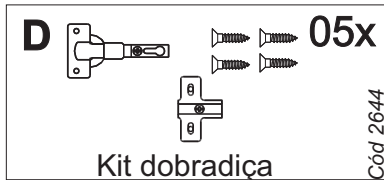
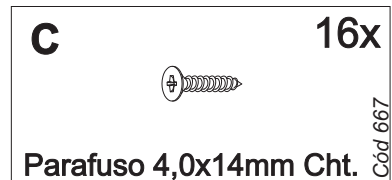
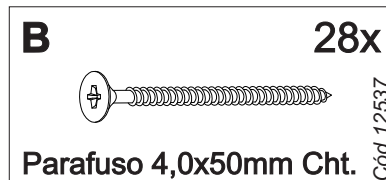
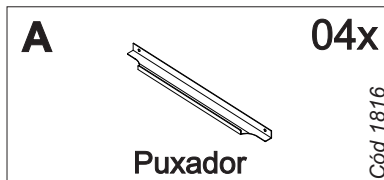

Medidas em mm

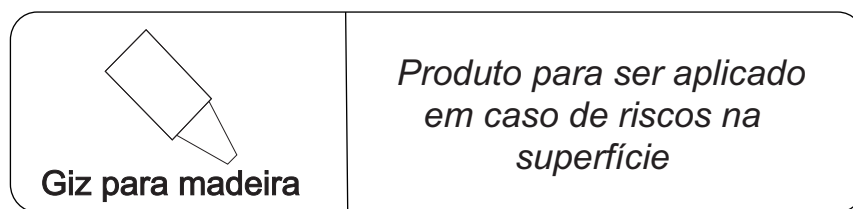
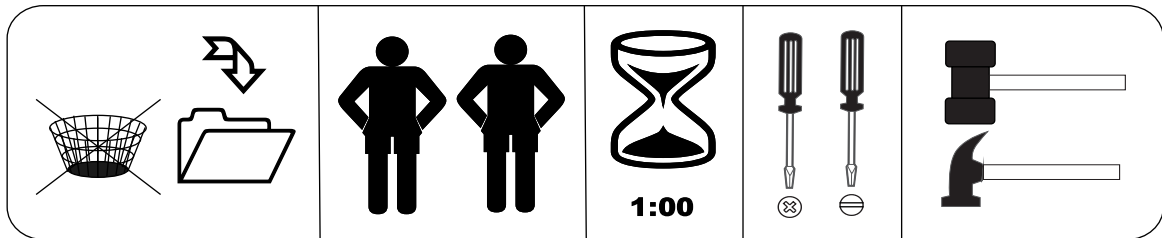

## Pré-Montagem/Preparación Piezas

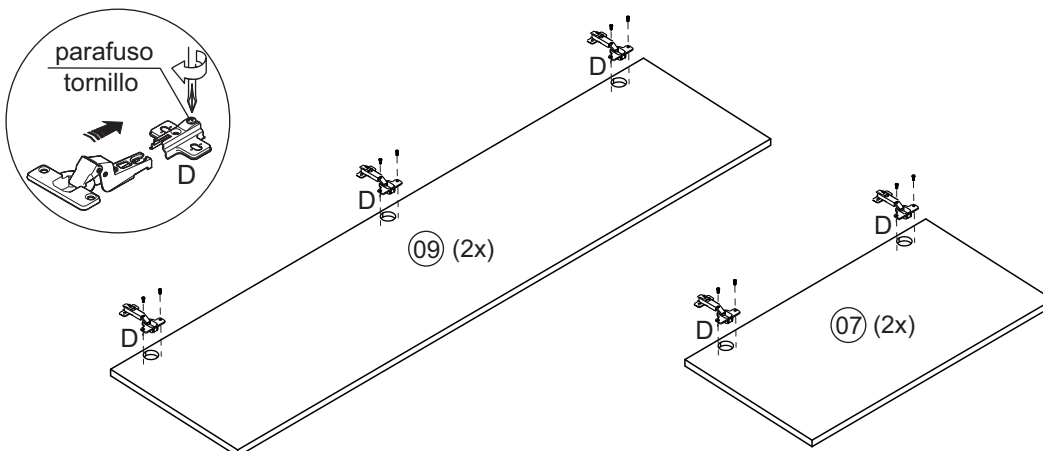

# Montagem/Montaje

01

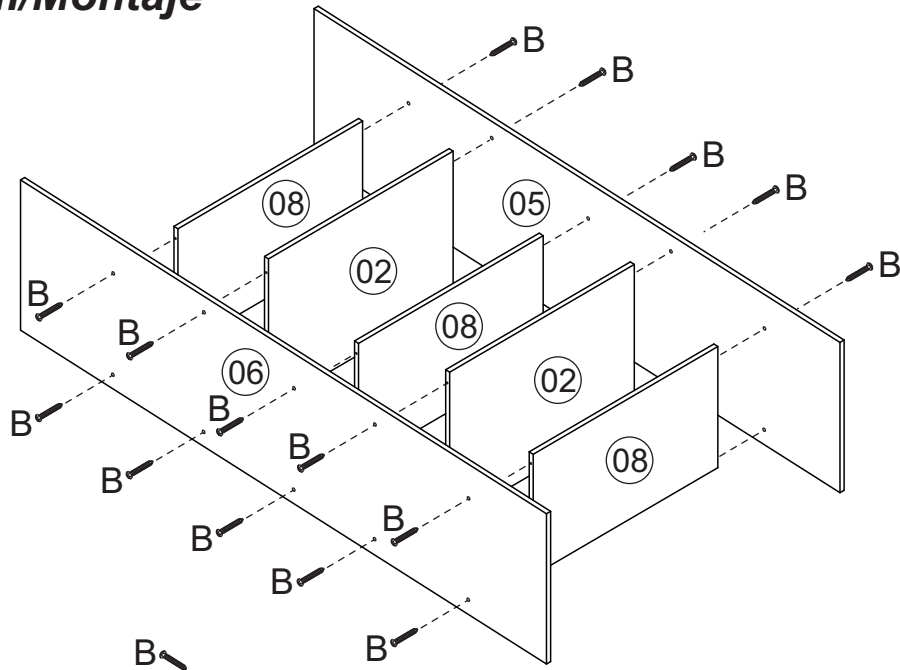

02

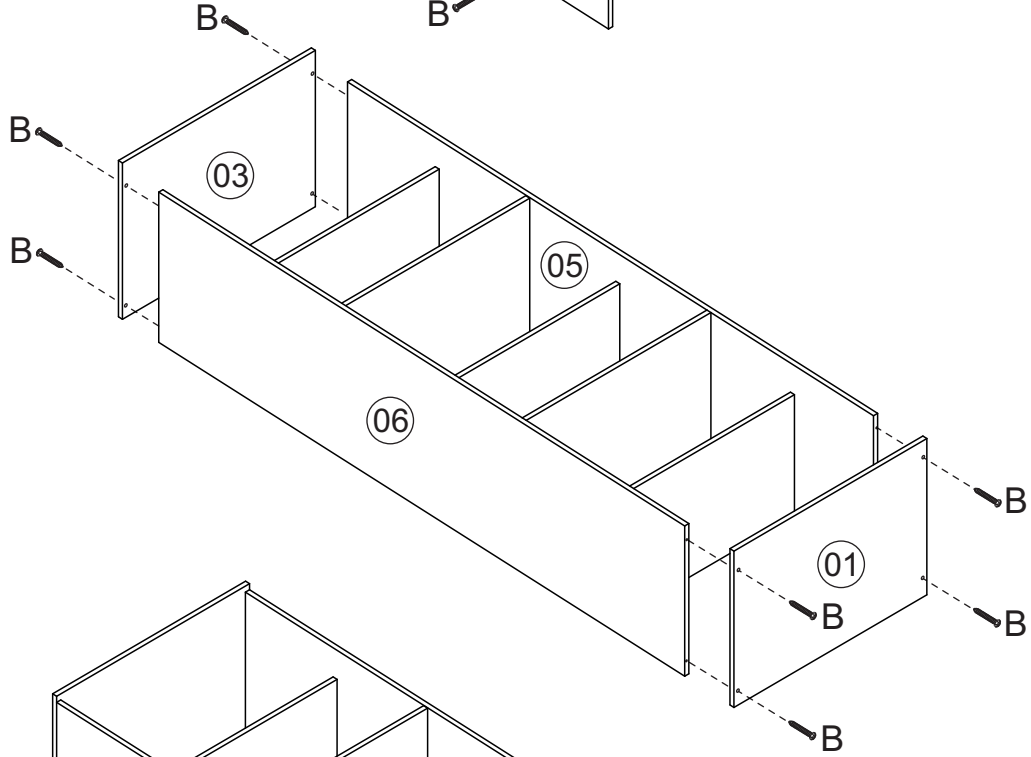

03

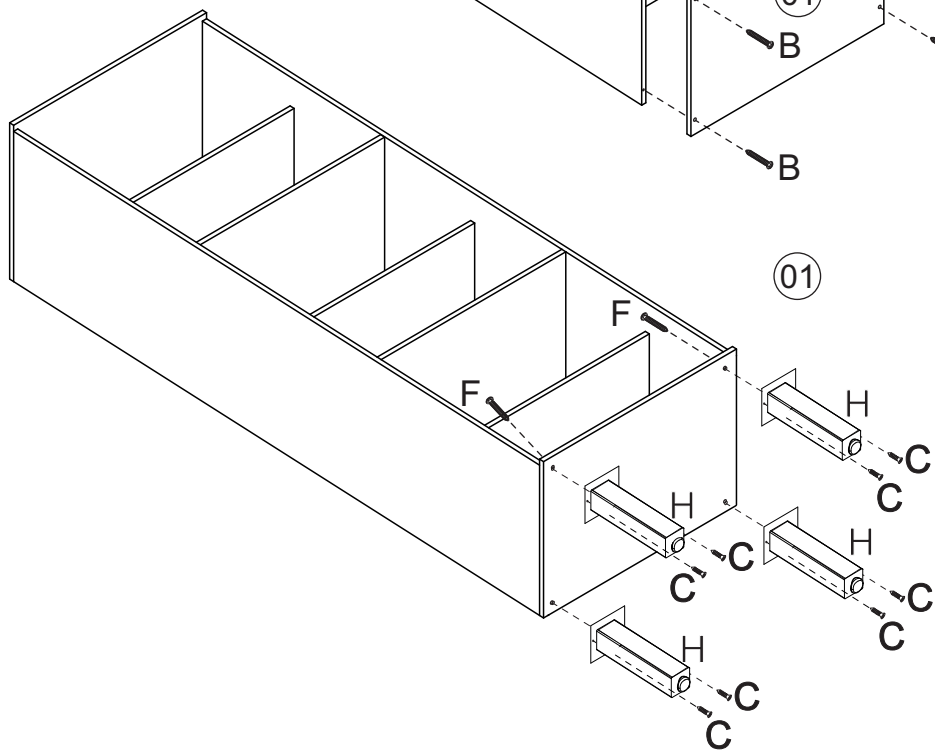

# Montagem/Montaje

04

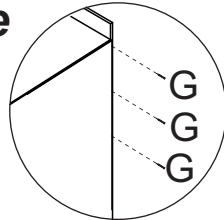

\*Colocar um prego (G) a cada 100mm.

## ATENÇÃO!!!

É importante colocar o móvel no esquadro antes de fixar as costas. Para isto utilize uma trena observando que a medida 1 deve ser igual à medida 2.

## ATENCIÓN!!!

Es importante hacer una escuadra perfecta entre el fondo y la estructura del mueble. Observe que la medida 1 debe ser la misma que la medida 2.

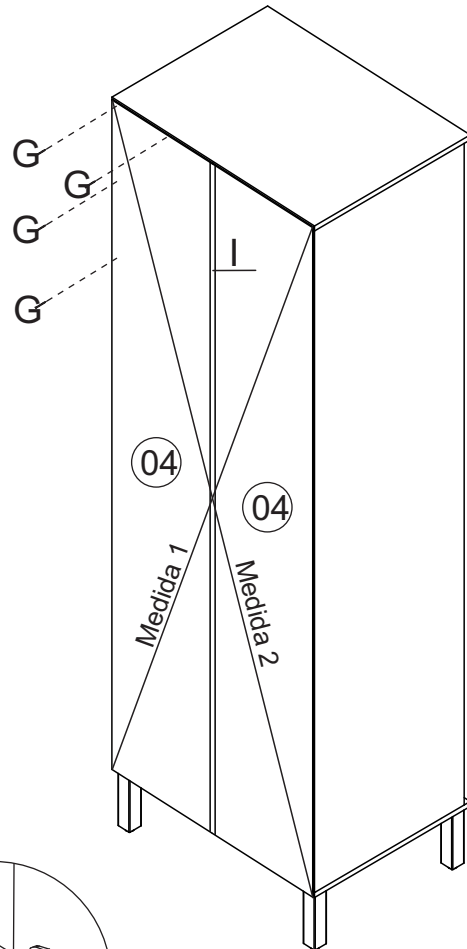

05

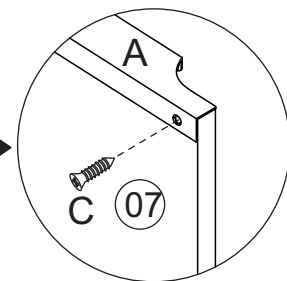
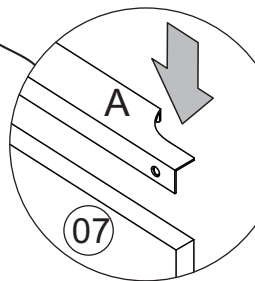
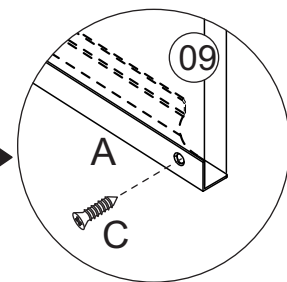
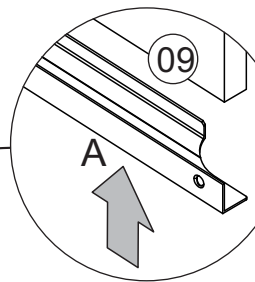
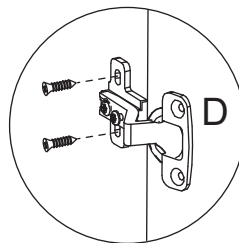
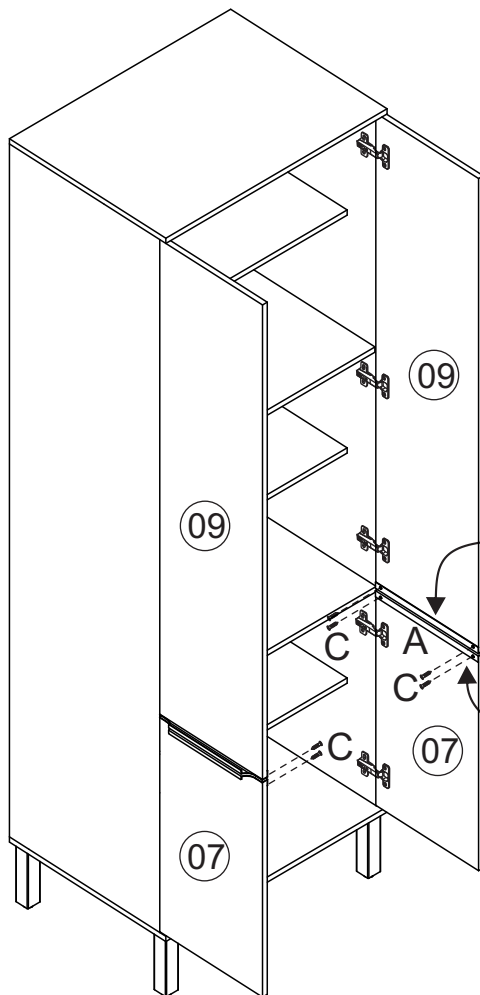

\*Usar os outros 4 parafusos (E) para unir este módulo a outro.

Usar los otros tornillos (E) para unirse este modulo a otro.

### Limpeza/Limpieza

- ≠ Use um pano levemente umedecido com água, seguido de pano seco.
- ≠ Use solamente un paño húmedo con agua y después un paño seco.
- ≠ Nunca utilize produtos químicos ou abrasivos.
- ≠ No utilice productos quimicos o abrasivos.